



E SERIES PROPORTIONAL FLOW CONTROLS

Flow Control / Flow Control and Check /
Flow Control and Relief

**PROPORTIONAL
CONTROLS**

General Information

Up to 24.5 MPa (3550 PSI), 500 L/m in (132 U.S.GPM)

■ Flow Control / Flow Control and Check Valves

These valves vary their output flow proportionally to an input current, therefore, by controlling the input current from the power amplifier, the flow rate in the system can be continuously, remotely and optionally regulated. Furthermore, as the valves have the functions of pressure and temperature compensation, the flow rate is not affected by the variation in the pressure (load) and temperature (viscosity of hydraulic fluids).

These valves are optimal for such a usage where the start-up, stop and speed change of the actuator are required to be done without shocks. The valves are used together with the applicable power amplifiers.

● 40Ω Series.....

Page 22 Direct-acting model designed to control the throttle with a high-power solenoid is employed, providing a high strength against contamination in oil and an outstanding reliability.

● 10Ω Series.....Page 44

hydraulic pilot amplification model is employed, achieving a small hysteresis with a small solenoid.

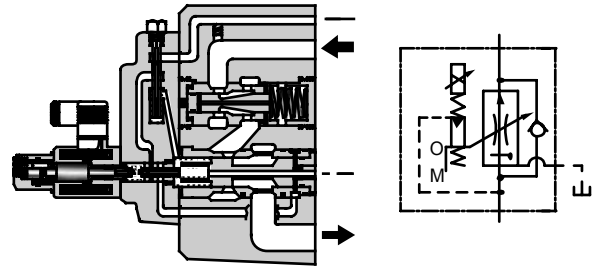
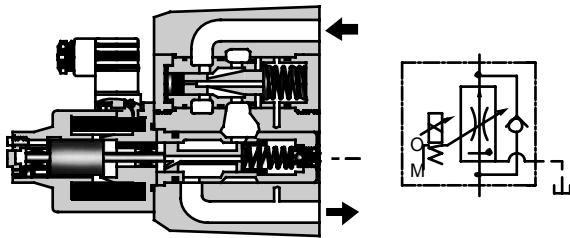

■ Flow Control and Relief Valves

These valves control the pump pressure effectively by responding to a small pressure difference against the load pressure. Therefore, it can be said that they are energy-saving metre-in type flow control valves which can be operated at a low power consumption. Furthermore, as the valves have temperature compensator, the stable control of the flow rate is possible irrespective of change in the oil temperature.

● 40Ω - 10Ω Series Page 22

For flow control, a direct-acting model using a high-power solenoid is employed, providing an outstanding reliability.

● 10Ω - 10Ω Series Page 33

For flow control, a hydraulic pilot amplification model is employed, providing a small hysteresis.

● High Flow Series Page 44

Parts have been improved, doubling the maximum controlled flow, which enables the equipment to be compacted.

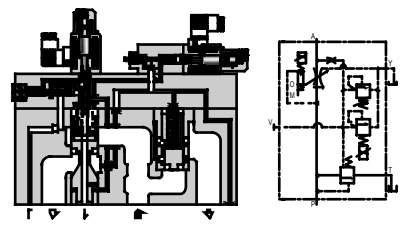
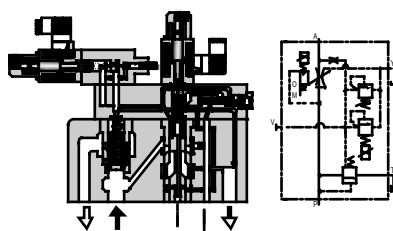
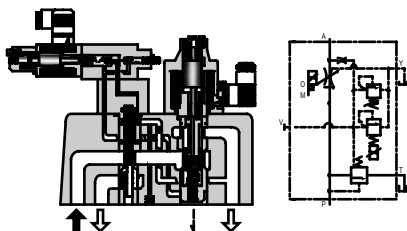

Hydraulic Fluids

■ Hydraulic Fluids

● Fluid Types

Any type of hydraulic fluid listed in the table below can be used.

Petroleum Base Oils	Use fluids equivalent to ISO VG 32 or VG 46.
Synthetic Fluids	Use phosphate ester or polyol ester fluids. When phosphate ester fluid is used, prefix "F-" to the model number because the special seals (fluororubber) are required to be used.
Water-Containing Fluids	Use water-glycol fluid.

Note: For use with hydraulic fluids other than those listed above, please consult your Yuken representatives in advance.

● Recommended Fluid Viscosity and Temperature

Use hydraulic fluids which satisfy the both recommended viscosity and oil temperatures given in the table below.

Name	Viscosity	Temperature
Flow Control Valves	20 - 200 mm ² /s (98 - 900 SSU)	-15 - +70°C (5 - 160°F)
Flow Control and Check Valves		
Flow Control and Relief Valves		

● Control of Contamination

Due caution must be paid to maintaining control over contamination of the hydraulic fluids which may otherwise lead to breakdowns and shorten the life of the valve. Please maintain the degree of contamination within NAS 1638-Grade 11. Use 20 μm or finer line filter.

Instructions

■ Mounting Positioning Orientation

Be sure that the air vent faces up. The air vent position can be changed as desired.

If the pressure control solenoid of the EFBG valve is mounted vertically, the minimum adjustment pressure is 2 MPa (290 PSI) or higher.

[Good example]

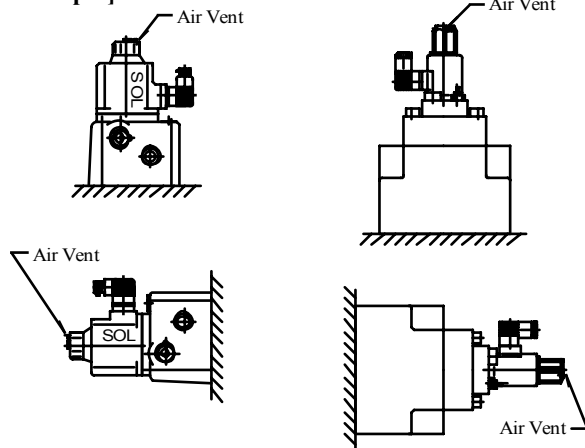

[Bad example]

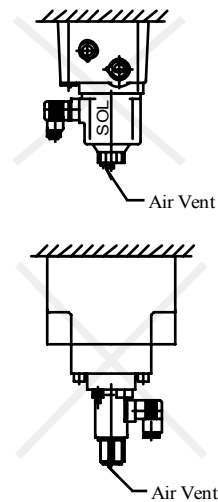

■ Air Bleeding

To ensure stable control, bleed the air from solenoid completely and fill its iron core with oil.

Bleeding can be done by slowly loosening an air vent. The 10Ω series solenoid has three air vents. Choose one that appears most helpful (see the figure below).

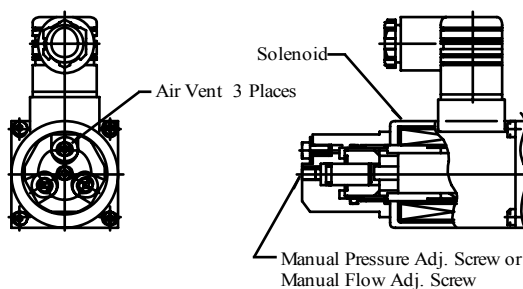

10 Ω Series Solenoid

■ Manual Adjustment Screw

When initial adjustments are to be made or when no current is supplied to the valve due to electrical failure or other problem, turn the manual adjustment screw to temporarily set the valve pressure and flow rate. In that case, when turn the manual adjustment screw clockwise, the valve pressure rises and flow increase. Under normal conditions, however, this screw must be kept in its original position (see the figure below).

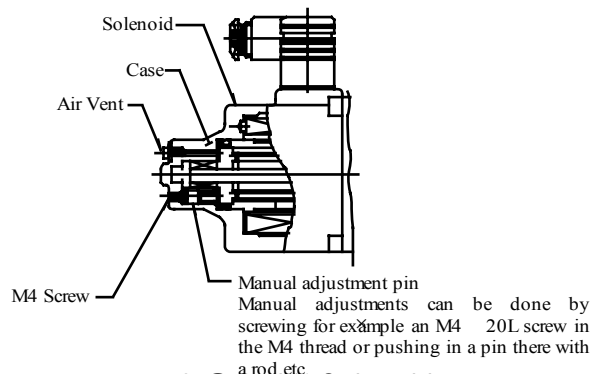

40 Ω Series Solenoid

■ Tank and Drain Piping

The tank-line back pressure and drain back pressure directly affect the minimum adjustment pressure or flow adjustment valve main spool operating force. Therefore, do not connect the tank or drain pipes to other lines, but connect them directly to the reservoir maintaining the back pressure as low as possible. Be sure that the tank and drain pipe ends are immersed in fluid.

■ Hysteresis and Repeatability Value Indications

The hysteresis and repeatability values indicated in the specifications for each control valve are determined under the following conditions:

- Hysteresis Value: Obtained when Yuken's applicable power amplifier is used.
- Repeatability Value: Obtained when Yuken's applicable power amplifier is used under the same conditions.

■ Specifications

Model No. Description	EFG EFCG -02-10 30	EFG EFCG -03- 60 125	EFG EFCG -06-250	EFG EFCG -10-500
Max. Operating Pres. MPa (PSI)	20.6 (3000)	20.6 (3000)	20.6 (3000)	20.6 (3000)
Metred Flow Adjustment Range L/min (U.S.GPM)	10: 0.3-10 (.08-2.6) 30: 0.3-30 (.08-7.9)	60: 2-60 (.53-15.9) 125: 2-125 (.53-33)	3-250 (.79-66)	5-500 (1.32-132)
Min. Differential Pres. ^A MPa (PSI)	0.6 (90)	1.0 (145)	1.3 (190)	2.0 (290)
Free Flow (EFCG Models Only.) L/min (U.S.GPM)	40 (10.6)	130 (34.3)	280 (74.0)	550 (145)
Rated Current	600 mA	600 mA	600 mA	700 mA
Coil Resistance	43.5 Ω	43.5 Ω	43.5 Ω	43.5 Ω
Hysteresis	Less than 5%	Less than 7%	Less than 7%	Less than 7%
Repeatability	Less than 1%	Less than 1%	Less than 1%	Less than 1%
Approx. Mass kg (lbs.)	8.2 (18.1)	12.5 (27.6)	25 (55.1)	51 (113)

★ Min. pressure difference required between inlet and outlet ports to maintain function as pressure compensator.

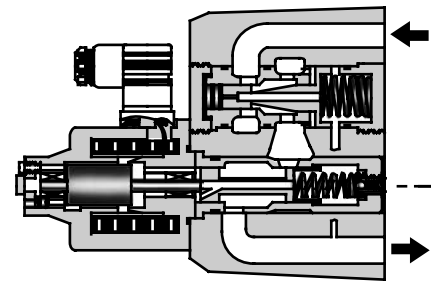

■ Model Number Designation

EFC	G	-02	-10	-31	*
Series Number	Type of Mounting	Valve Size	Max. Metred Flow L/min (U.S.GPM)	Design Number	Design Standards
EF: Proportional Electro-Hydraulic Flow Control Valve	G: Sub-plate Mounting	02	10: 10 (2.6) 30: 30 (7.9)	31	Refer to ★
EFC: Proportional Electro-Hydraulic Flow Control and Check Valve		03	60: 60 (15.9) 125: 125 (33)	26	
		06	250: 250 (66)	22	
		10	500: 500 (132)	11	

Note: If you are going to use the model with pressure compensator stroke adjustment screw, consult your Yuken representative in advance.

★ Design Standards: None Japanese Standard "JIS" and European Design Standard
90 N. American Design Standard

Graphic Symbols

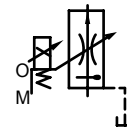

EFG-*

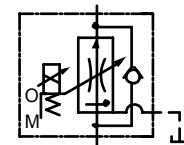

EFCG-*

■ Attachment

● Mounting Bolts

Valve Model Numbers	Socket Head Cap Screw		Qty.
	Japanese Std. "JIS" and European Design Std.	N. American Design Std.	
EF*G-02	M8 × 75 Lg.	5/16-18 UNC × 3 Lg.	4
EF*G-03	M10 × 100 Lg.	3/8-16 UNC × 4 Lg.	4
EF*G-06	M16 × 130 Lg.	5/8-11 UNC × 5 Lg.	4
EF*G-10	M20 × 160 Lg.	3/4-10 UNC × 6-1/2 Lg.	4

■ Applicable Power Amplifiers

For stable performance, it is recommended that Yuken's applicable power amplifiers be used (for details see the Catalogue No. Pub. EC-1305).

Model Numbers: AME-D-S-* -32
 AME-DF-S-* -22
 AME-T-S-* -22

■ Sub-plate

Valve Model Numbers	Japanese Standard "JIS"		European Design Standard		N. American Design Standard		Approx. Mass kg (lbs.)
	Sub-plate Model Numbers	Thread Size	Sub-plate Model Numbers	Thread Size	Sub-plate Model Numbers	Thread Size	
EFG EFCG -02	EFGM-02X-20	Rc 3/8	EFGM-02X-2080	3/8 BSP.F	EFGM-02X-2090	3/8 NPT	2.3 (5.1)
	EFGM-02Y-20	Rc 1/2	EFGM-02Y-2080	1/2 BSP.F	EFGM-02Y-2090	1/2 NPT	3.1 (6.8)
EFG EFCG -03	EFGM-03Y-20	Rc 3/4	EFGM-03Y-2080	3/4 BSP.F	EFGM-03Y-2090	3/4 NPT	5.7 (12.6)
	EFGM-03Z-20	Rc 1	EFGM-03Z-2080	1 BSP.F	EFGM-03Z-2090	1 NPT	5.6 (12.3)
EFG EFCG -06	EFGM-06X-20	Rc 1	EFGM-06X-2080	1 BSP.F	EFGM-06X-2090	1 NPT	12.5 (27.6)
	EFGM-06Y-20	Rc 1-1/4	EFGM-06Y-2080	1-1/4 BSP.F	EFGM-06Y-2090	1-1/4 NPT	16 (35.3)
EFG EFCG -10	EFGM-10Y-10 [★]	1-1/2, 2 Flange Mounting	EFGM-10Y-1080 [★]	1-1/2, 2 Flange Mounting	EFGM-10Y-1090 [★]	1-1/2, 2 Flange Mounting	37 (81.6)

● Sub-plates are available. Specify the sub-plate model number from the table above. When sub-plates are not used, the mounting surface should have a good machined finish.

★ When ordering the EFGM-10Y, see Type F3 Pipe Flange Kits on Catalogue No. Pub. EC-3001 and order an appropriate pipe flange kit also.

■ Models with Pressure Compensator Stroke Adjustment Screw

A models with pressure compensator stroke adjustment screw is optionally available to minimize the actuator protrusion (jumping) at startup. For the details, please consult us or your Yuken distributors.

■ Instructions

● Drain Back Pressure

Check that the drain back pressure does not exceed 0.2 MPa (29 PSI).

● Models with Check Valve

A models with check valve makes it possible to obtain a free flow in the direction opposite that of the controlled flow without respect to the input current.

Installation Drawing

EFG/EFCG-02-* -31/3190

EFG/EFCG-03-* -26/2690

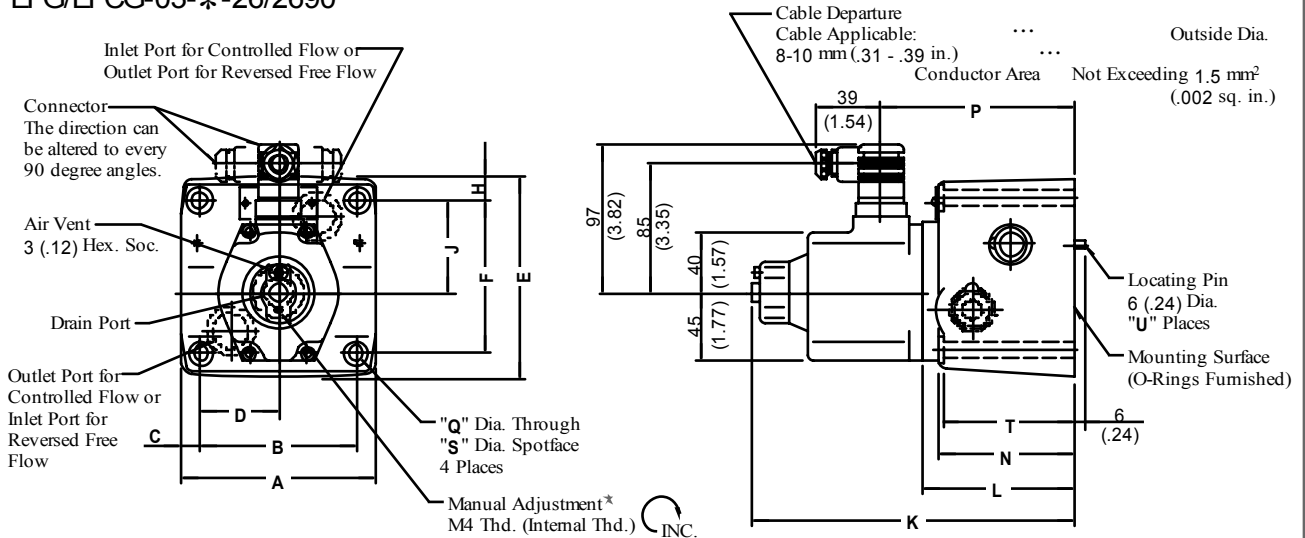

★ Manual adjustment can be done by screwing for example an M4×20 L screw in the M4 thread or pushing in a rod etc. there.

Model Numbers	Dimensions mm (Inches)															U
	A	B	C	D	E	F	H	J	K	L	N	P	Q	S	T	
EF*G-02	96 (3.78)	76.2 (3.00)	9.9 (.39)	38.1 (1.50)	106 (4.17)	82.6 (3.25)	11.7 (.46)	46.3 (1.82)	195 (7.68)	81 (3.19)	66 (2.60)	108 (4.25)	8.8 (.35)	14 (.55)	65 (2.56)	1
EF*G-03	125 (4.92)	101.6 (4.00)	11.7 (.46)	50.8 (2.00)	130 (5.12)	101.6 (4.00)	14.2 (.56)	61.8 (2.43)	212 (8.35)	98 (3.86)	85 (3.35)	125 (4.92)	11 (.43)	17.5 (.69)	84 (3.31)	2

EFG/EFCG-06-250-22/2290

EFG/EFCG-10-500-11/1190

DIMENSIONS IN
MILLIMETRES (INCHES)

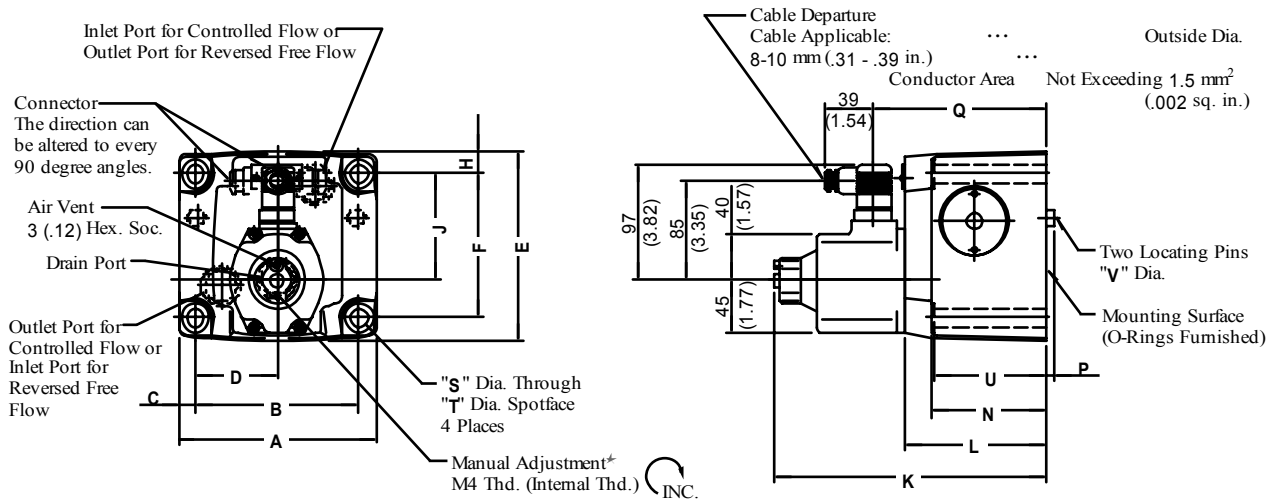

★ Manual adjustment can be done by screwing for example an M4×20 L screw in the M4 thread or pushing in a rod etc. there.

Model Numbers	Dimensions mm (Inches)																
	A	B	C	D	E	F	H	J	K	L	N	P	Q	S	T	U	V
EF*G-06	180 (7.09)	146.1 (5.75)	17 (.67)	73.1 (2.88)	174 (6.85)	133.4 (5.25)	20.3 (.80)	99 (3.90)	244 (9.61)	130 (5.12)	105 (4.13)	7 (.28)	157 (6.18)	17.5 (.69)	26 (1.02)	103.5 (4.07)	16 (.63)
EF*G-10	244 (9.61)	196.9 (7.75)	23.5 (.93)	98.5 (3.88)	228 (8.98)	177.8 (7.00)	25 (.98)	144.5 (5.69)	274 (10.79)	160 (6.30)	137 (5.93)	10 (.39)	187 (7.36)	21.5 (.85)	32 (1.26)	135 (5.31)	18 (.71)

Installation Drawing

Sub-plate

EFGM-02X/02Y-20/2080/2090

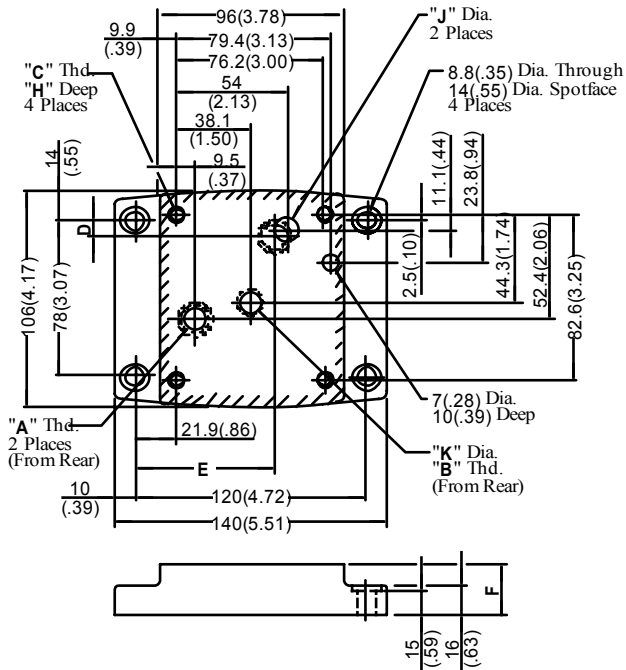

Sub-plate Model Numbers	Thread Size		
	"A" Thd.	"B" Thd.	"C" Thd.
EFGM-02X-20	Rc 3/8	Rc 1/4	M8
EFGM-02Y-20	Rc 1/2		
EFGM-02X-2080	3/8 BSP.F	1/4 BSP.F	
EFGM-02Y-2080	1/2 BSP.F		
EFGM-02X-2090	3/8 NPT	1/4 NPT	5/16-18 UNC
EFGM-02Y-2090	1/2 NPT		

Sub-plate Model Numbers	Dimensions mm (Inches)					
	D	E	F	H	J	K
EFGM-02X-20	8.6 (.34)	75.9 (2.99)	25 (.98)	14 (.55)	14 (.55)	11 (.43)
EFGM-02Y-20	11.5 (.45)	72.9 (2.87)	35 (1.38)		15.2 (.60)	11.7 (.46)
EFGM-02X-2080	8.6 (.34)	75.9 (2.99)	25 (.98)		15.2 (.60)	11.7 (.46)
EFGM-02Y-2080	11.5 (.45)	72.9 (2.87)	35 (1.38)		15 (.59)	
EFGM-02X-2090	8.6 (.34)	75.9 (2.99)	25 (.98)	18 (.17)	14 (.55)	11 (.43)
EFGM-02Y-2090	11.5 (.45)	72.9 (2.87)	35 (1.38)			

DIMENSIONS IN
MILLIMETRES (INCHES)

EFGM-03Y/03Z-20/2080/2090

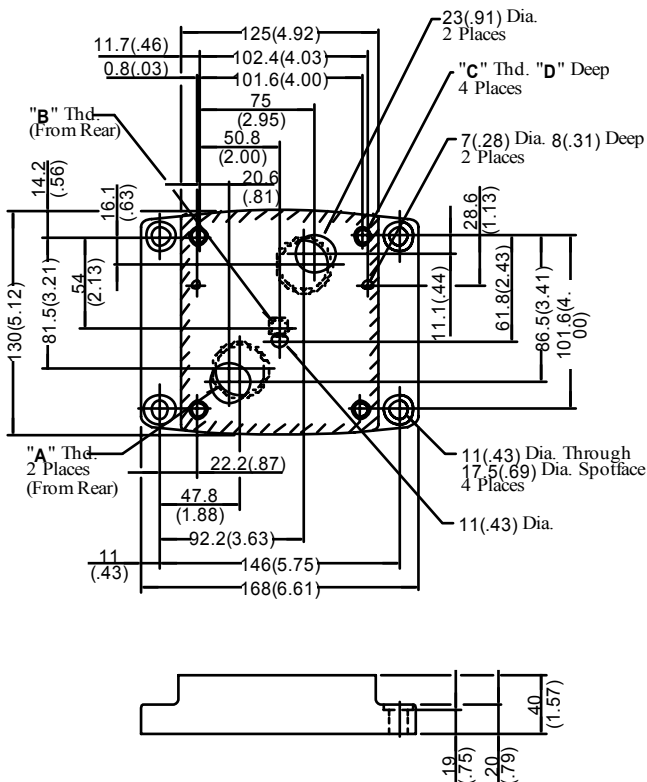

Sub-plate Model Numbers	Thread Size			D mm (in.)
	"A" Thd.	"B" Thd.	"C" Thd.	
EFGM-03Y-20	Rc 3/4	Rc 1/4	M10	18 (.71)
EFGM-03Z-20	Rc 1			
EFGM-03Y-2080	3/4 BSP.F	1/4 BSP.F		
EFGM-03Z-2080	1 BSP.F			
EFGM-03Y-2090	3/4 NPT	1/4 NPT	3/8-16 UNC	21 (.83)
EFGM-03Z-2090	1 NPT			

Installation Drawing

EFGM-06X/06Y-20/2080/2090

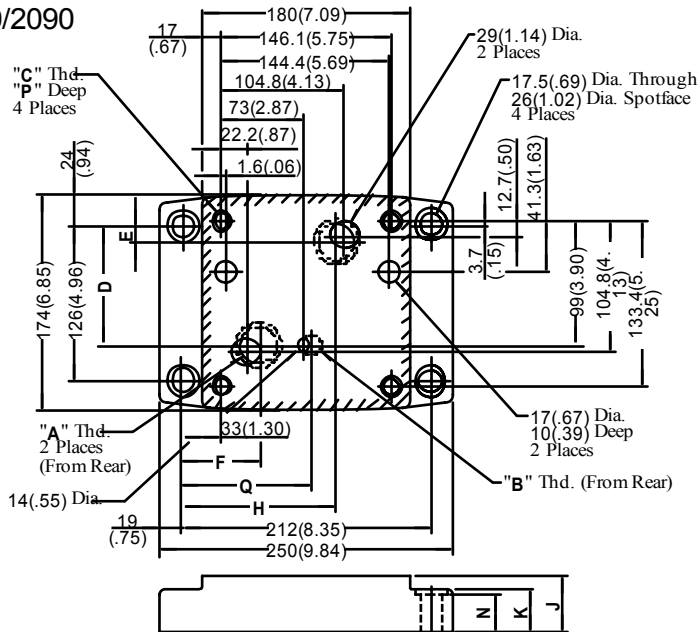

Sub-plate Model Numbers	Thread Size			Dimensions mm (Inches)										
	"A" Thd.	"B" Thd.	"C" Thd.	D	E	F	H	J	K	N	P	Q	S	
EFGM-06X-20	Rc 1	Rc 3/8	M16	101.1 (3.98)	14.3 (.56)	55.2 (2.17)	137.8 (5.43)	45 (1.77)	35 (1.38)	34 (1.34)	30 (1.18)	106 (4.17)	14 (.55)	
EFGM-06Y-20	Rc 1-1/4			95.3 (3.75)	19.3 (.76)	67 (2.64)	132 (5.20)	60 (2.36)	40 (1.57)	39 (1.54)				
EFGM-06X-2080	1 BSP.F	3/8 BSP.F		101.1 (3.98)	14.3 (.56)	55.2 (2.17)	137.8 (5.43)	45 (1.77)	35 (1.38)	34 (1.34)		35 (1.38)	106 (4.17)	14 (.55)
EFGM-06Y-2080	1-1/4 BSP.F			95.3 (3.75)	19.3 (.76)	67 (2.64)	132 (5.20)	60 (2.36)	40 (1.57)	39 (1.54)				
EFGM-06X-2090	1 NPT	3/8 NPT		5/8-11 UNC	101.1 (3.98)	14.3 (.56)	55.2 (2.17)	137.8 (5.43)	45 (1.77)	35 (1.38)	34 (1.34)	35 (1.38)	106 (4.17)	14 (.55)
EFGM-06Y-2090	1-1/4 NPT				95.3 (3.75)	19.3 (.76)	67 (2.64)	132 (5.20)	60 (2.36)	40 (1.57)	39 (1.54)			

EFGM-10Y-10/1080/1090

DIMENSIONS IN
MILLIMETRES (INCHES)

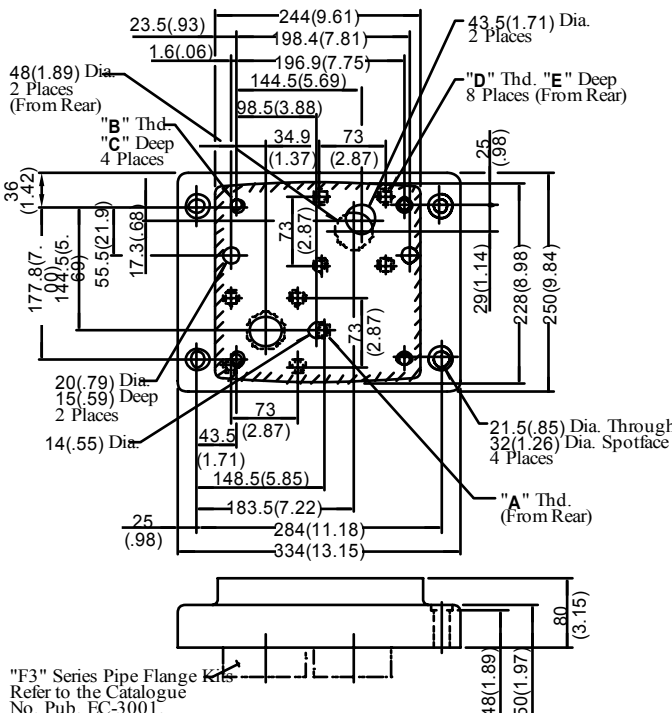

Sub-plate Model Numbers	Thread Size		
	"A" Thd.	"B" Thd.	"C" Thd.
EFGM-10Y-10	Rc 3/8	M20	M16
EFGM-10Y-1080	3/8 BSP.F		
EFGM-10Y-1090	3/8 NPT	3/4-10 UNC	5/8-11 UNC

Sub-plate Model Numbers	mm (Inches)	
	D	E
EFGM-10Y-10	30 (1.18)	30 (1.18)
EFGM-10Y-1080	30 (1.18)	30 (1.18)
EFGM-10Y-1090	34 (1.34)	35 (1.38)

"F3" Series Pipe Flange Kits
Refer to the Catalogue
No. Pub. EC-3001.

Typical Performance Characteristics

Input Current vs. Flow

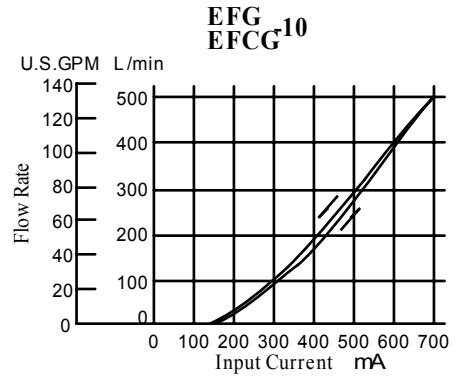
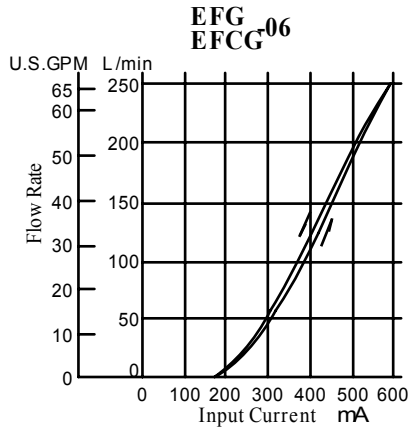
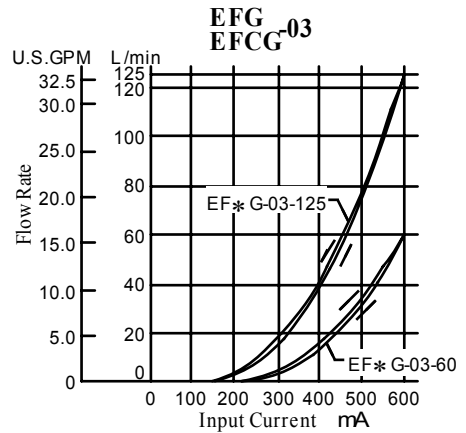
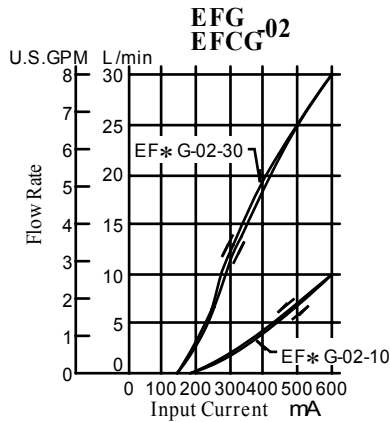

Differential Pressure vs. Metred Flow

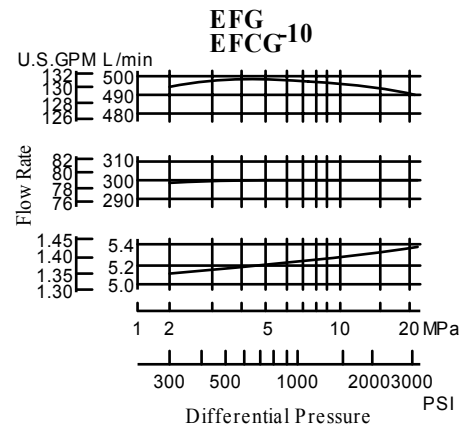
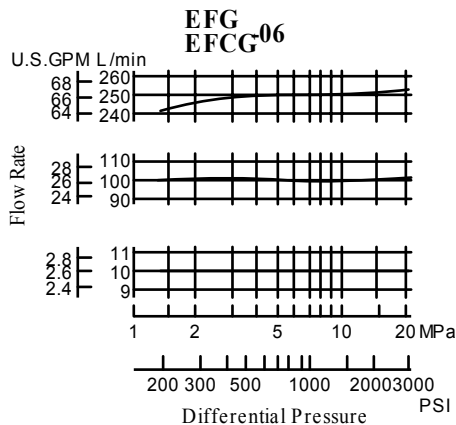
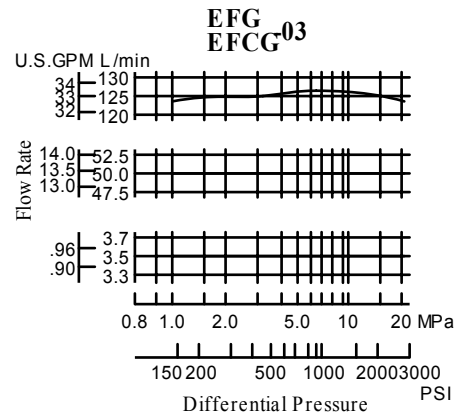
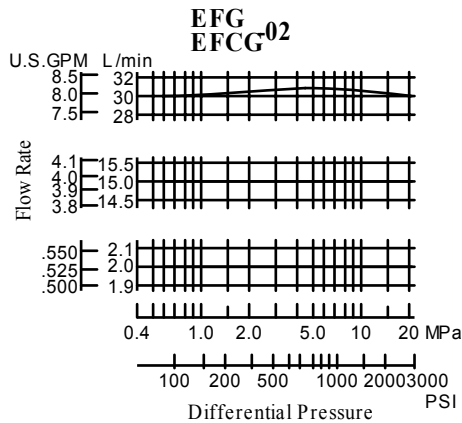

Typical Performance Characteristics

Step Response

These characteristics have been obtained by measuring on each valve. Therefore, they may vary according to a hydraulic circuit to be used.

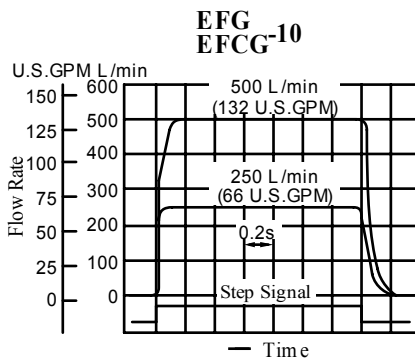
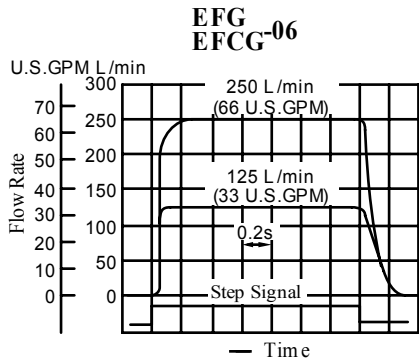
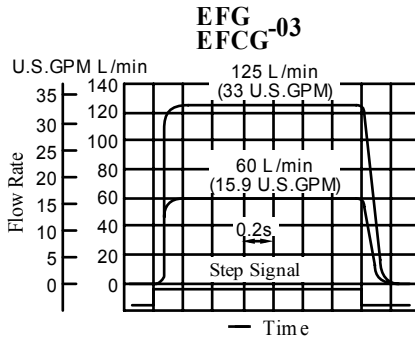
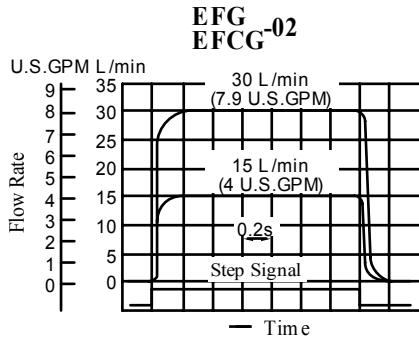

Viscosity vs. Flow

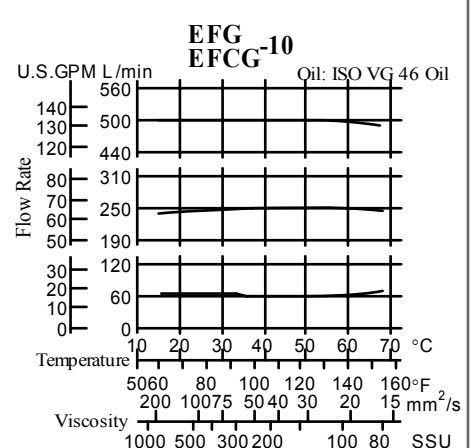
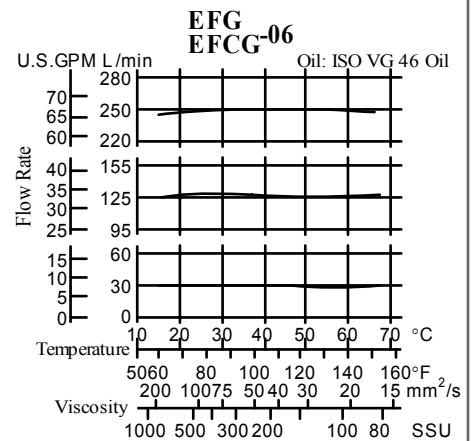
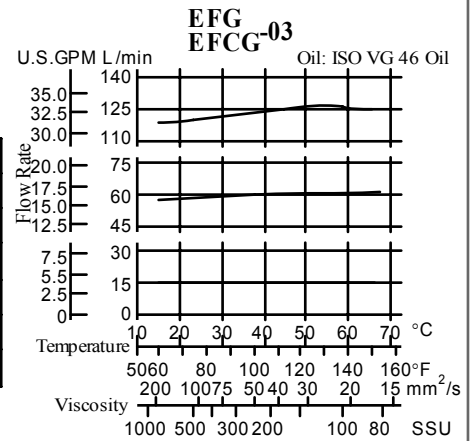
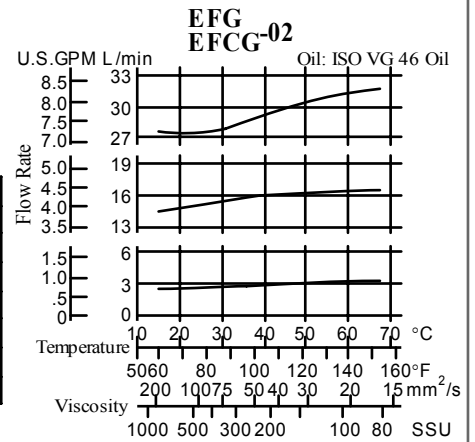

Frequency Response

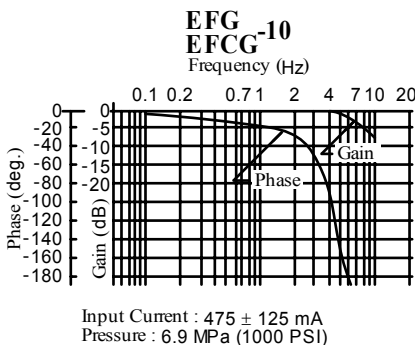
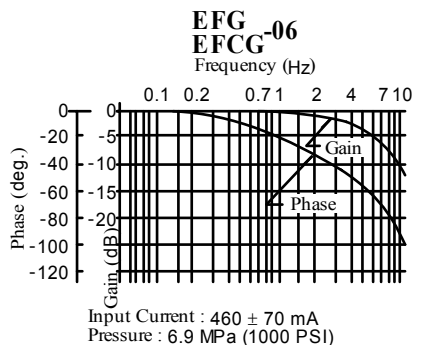
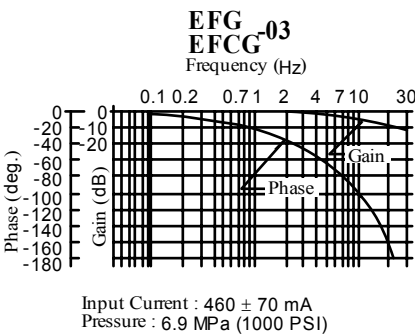
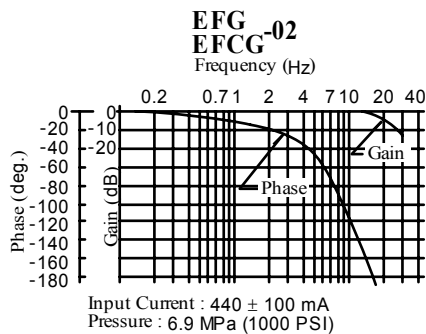

Typical Performance Characteristics

■ Pressure Drop for Reversed Free Flow (Only for "EFCG" Models)

Oil Viscosity: 35 mm²/s (164 SSU)
Specific Gravity: 0.850

EFCG-02

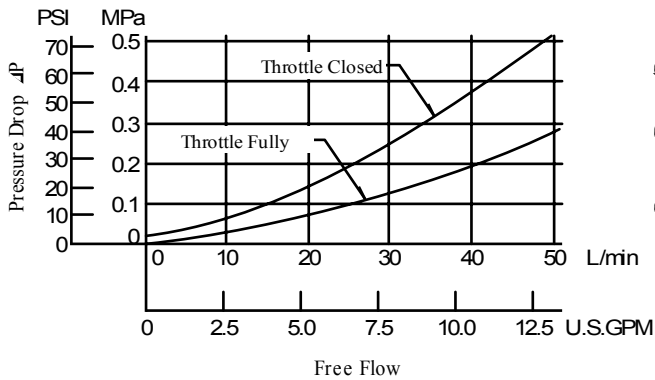

EFCG-03

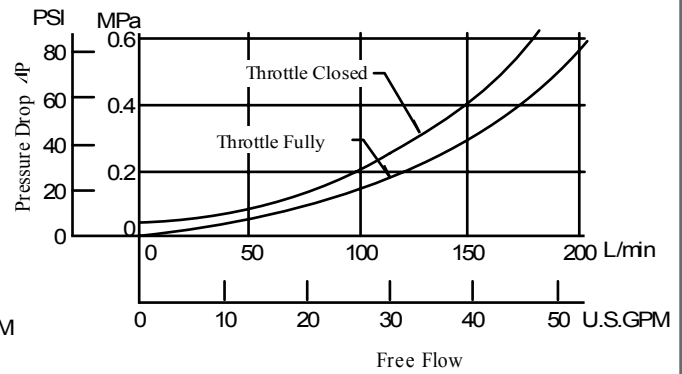

EFCG-06

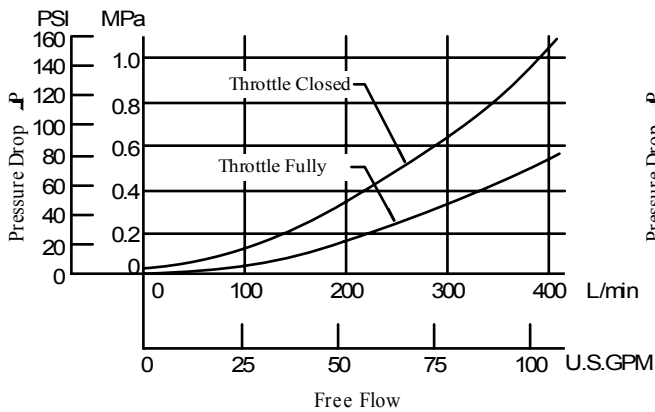

EFCG-10

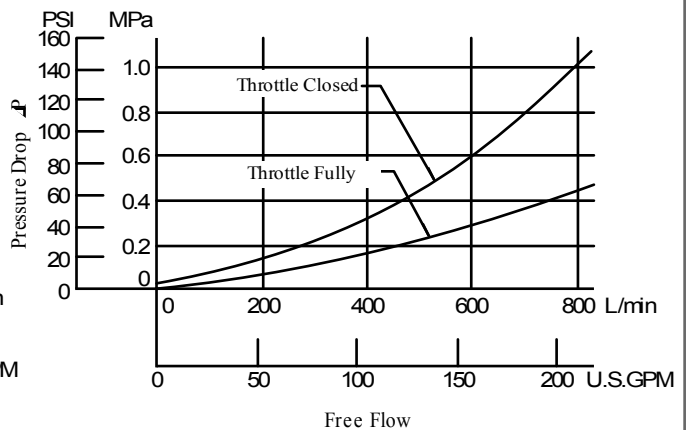

● For any other viscosity, multiply the factors in the table below.

Viscosity	mm ² /s	20	40	60	80	100
	SSU		98	186	278	371
Factor		0.87	1.03	1.14	1.23	1.30

● For any other specific gravity (G'), the pressure drop(ΔP') may be obtained from the formula below.
 $\Delta P' = \Delta P (G'/0.850)$



Spare Parts List

EFG/EFCG-02-* -31/3190

EFG/EFCG-03-* -26/2690

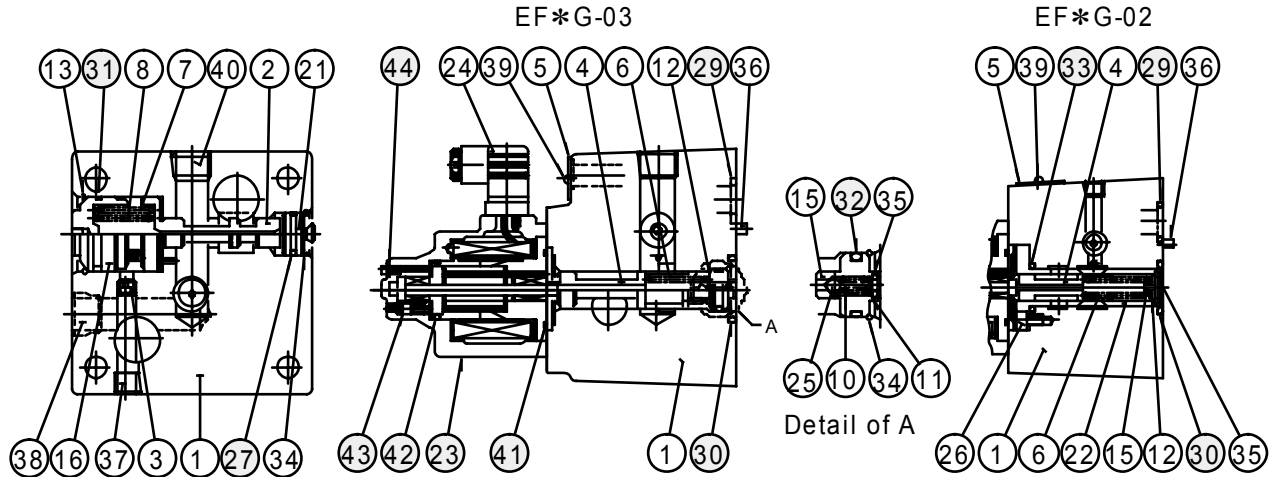

With Check Valve (EFCG-02, 03)

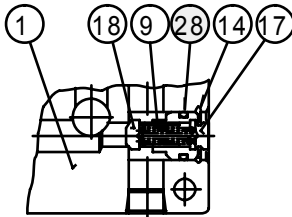

CAUTION

When making replacement of seals, please do it carefully after reading through the relevant instructions in the Operator's Manual.

● List of Seals and Solenoids Ass'y

Item	Name of Parts	Part Numbers		Qty.
		EF*G-02	EF*G-03	
23	Solenoid Ass'y	E321-45-20	E321-45-20	1
27	O-Ring	SO-NB-P18	SO-NB-P18	1
28	O-Ring	SO-NB-P10A	SO-NB-P21	1
29	O-Ring	SO-NB-P18	SO-NB-P28	2
30	O-Ring	SO-NB-P22	SO-NB-P31	1
31	O-Ring	SO-NB-G25	SO-NB-G35	1
32	O-Ring	—	SO-NB-P18	1
33	O-Ring	SO-NB-P22	—	1
41	O-Ring	SO-NB-G45	SO-NB-G45	1
42	O-Ring	SO-NB-G35	SO-NB-G35	1
43	O-Ring	SO-NA-P4	SO-NA-P4	1
44	Fastener Seal	SG-FCF-4	SG-FCF-4	1

Note: O-rings (Item 41, 42, 43) and the fastener seal (Item 44) are included in the solenoid assembly.

Note: The connector assembly GDM-211-B-11 (Item 24) is not included in the solenoid assembly.

Note: When ordering seals, please specify the seal kit number from the table right.

● List of Seal Kits

Model Numbers	Seal Kit Numbers
EFG-02-* -31*	KS-EFG-02-31
EFCG-02-* -31*	KS-EFCG-02-31
EFG-03-* -26*	KS-EFG-03-26
EFCG-03-* -26*	KS-EFCG-03-26

Spare Parts List

EFG/EFCG-06-250-22/2290

EFG/EFCG-10-500-11/1190

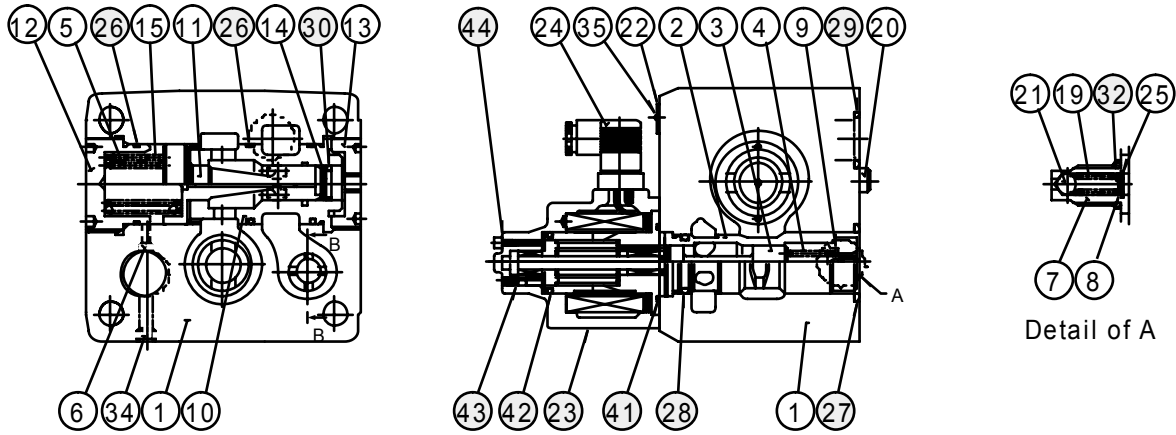

With Check Valve (EFCG-06, 10)

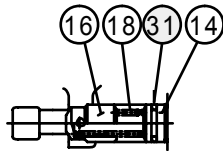

Section B-B

CAUTION

When making replacement of seals, please do it carefully after reading through the relevant instructions in the Operator's Manual.

● List of Seals and Solenoid Ass'y

Item	Name of Parts	Part Numbers		Qty.
		EF*G-06	EF*G-10	
23	Solenoid Ass'y	E321-45-20	E321-45-20	1
26	O-Ring	SO-NB-P50	SO-NB-G75	3
27	O-Ring	SO-NB-P44	SO-NB-G60	1
28	O-Ring	SO-NB-P34	SO-NB-P50	1
29	O-Ring	SO-NB-P32	SO-NB-P48	2
30	O-Ring	SO-NB-P21	SO-NB-P34	1
31	O-Ring	SO-NB-P21	SO-NB-P26	1
32	O-Ring	SO-NA-P10	SO-NA-P10	1
41	O-Ring	SO-NB-G45	SO-NB-G45	1
42	O-Ring	SO-NB-G35	SO-NB-G35	1
43	O-Ring	SO-NA-P4	SO-NA-P4	1
44	Fastener Seal	SG-FCF-4	SG-FCF-4	1

Note: O-rings (Item 41, 42, 43) and the fastener seal (Item 44) are included in the solenoid assembly.

Note: The connector assembly GDM-211-B-11 (Item 24) is not included in the solenoid assembly.

Note: When ordering seals, please specify the seal kit number from the table right.

● List of Seal Kits

Model Numbers	Seal Kit Numbers
EFG-06-250-22*	KS-EFG-06-22
EFCG-06-250-22*	KS-EFCG-06-22
EFG-10-500-11*	KS-EFG-10-11
EFCG-10-500-11*	KS-EFCG-10-11

■ Specifications

Description		Model No. EFG EFCG	03-60 03-125	EFG EFCG	06-250
Max. Operating Pressure MPa (PSI)			20.6 (3000)		24.5 (3550)
Metred Flow Adj. Range L/min (U.S.GPM)			60: 1-60 (.26-15.9) 125: 1-125 (.26-33)		2.5-250 (.66-66)
Min. Differential Pressure ^{★1} MPa (PSI)			1.0 (145)		1.0 (145)
Free Flow (EFCG Models Only) L/min (U.S.GPM)			130 (34.3)		280 (74.0)
Min Pilot Pressure ^{★2} MPa (PSI)			1.0 (145)		1.5 (220)
Pilot Flow L/min (U.S.GPM)	at Normal		0.5 (.13)		1 (.26)
	at Transition		2.6 (.69)		4 (1.06)
Rated Current			780 mA		820 mA
Coil Resistance			10 Ω		10 Ω
Hysteresis			Less than 3%		Less than 3%
Repeatability			Less than 1%		Less than 1%
Approx. Mass	kg (lbs.)		10 (22.1)		25 (55.1)

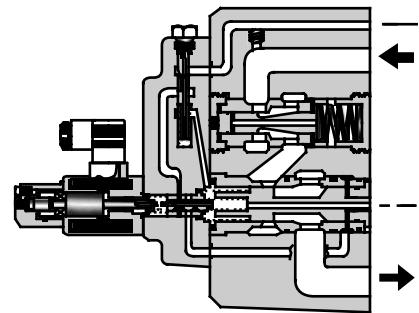

- ★ 1. Min pressure difference required between inlet and outlet ports to maintain function as pressure compensator.
- ★ 2. The minimum required value for the external pilot type.

■ Model Number Designation

EFC	G	-03	-125	-E	-51	*
Series Number	Type of Mounting	Valve Size	Max. Metred Flow L/min (U.S.GPM)	Pilot Connection	Design Number	Design Standards
EF: Proportional Electro-Hydraulic Flow Control Valve EFC: Proportional Electro-Hydraulic Flow Control and Check Valve	G: Sub-plate Mounting	03	60: 60 (15.9) 125: 125 (33)	None: Internal Pilot E: External Pilot	51	Refer to ★
		06	250: 250 (66)		51	

- ★ Design Standards: None Japanese Standard "JIS" and European Design Standard
 90 N. American Design Standard

Graphic Symbols

Internal Pilot

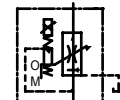

EFG-*

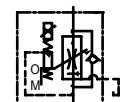

EFCG-*

External Pilot

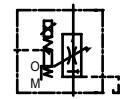

EFG-*

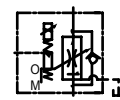

EFCG-*

■ Attachment

● Mounting bolts

Valve Model Numbers	Socket Head Cap Screw		Qty.
	Japanese Std. "JIS" and European Design Std.	N. American Design Std.	
EF*G-03	M10 × 80 Lg.	3/8-16 UNC × 3-1/4 Lg.	4
EF*G-06	M16 × 130 Lg.	5/8-11 UNC × 5 Lg.	4

■ Applicable Power Amplifiers

For stable performance, it is recommended that Yuken's applicable power amplifiers be used (for details see the Catalogue No. Pub. EC-1305).

Model Numbers: AME-D-10-* -20

AME-D2-1010-* -10

SK1022-* -*-11

SK1015-11 (For DC power supply)

AMN-D-10 (For DC power supply)

■ Sub-plate

Valve Model Numbers	Japanese Standard "JIS"		European Design Standard		N. American Design Standard		Approx. Mass kg (lbs.)
	Sub-plate Model Numbers	Thread Size	Sub-plate Model Numbers	Thread Size	Sub-plate Model Numbers	Thread Size	
EFG EFCG -03	EFGM-03Y-30	Rc 3/4	EFGM-03Y-3080	3/4 BSP.F	EFGM-03Y-3090	3/4 NPT	5.7 (12.6)
	EFGM-03Z-30	Rc 1	EFGM-03Z-3080	1 BSP.F	EFGM-03Z-3090	1 NPT	5.6 (12.3)
EFG EFCG -06	EFGM-06X-30	Rc 1	EFGM-06X-3080	1 BSP.F	EFGM-06X-3090	1 NPT	12.5 (27.6)
	EFGM-06Y-30	Rc 1-1/4	EFGM-06Y-3080	1-1/4 BSP.F	EFGM-06Y-3090	1-1/4 NPT	16 (35.3)

● Sub-plates are available. Specify the sub-plate model number from the table above. When sub-plates are not used, the mounting surface should have a good machined finish.

■ Instructions

● Drain Back Pressure

Check that the drain back pressure dose not exceed 0.2 MPa (29 PSI).

● Pilot Type Selection

This valve is constructed so as to operate at a pre-determined pilot pressure. For the 03, a pilot pressure of 1 MPa (145 PSI) or higher is required. For the 06, the requied pilot pressure is 1.5 MPa (220 PSI) or higher. To obtain such a required pilot pressure, select the pilot type according to the circuit examples on the right.

①/②

Use the external pilot type (pilot connection code: E) whether a metre-in or metre-out circuit is employed.

③

Use the internal pilot type (pilot connection code: None)

④

Use the external pilot type (pilot connection code: E)

[Example of Circuit]

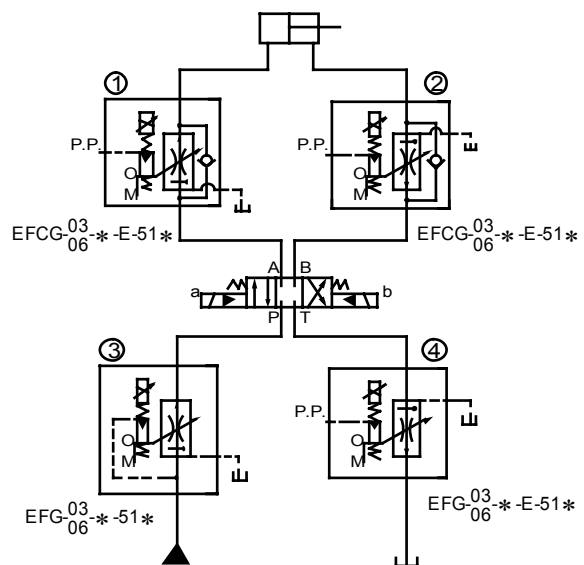

Installation Drawing

EFG
EFCG-03- 60
125*-51/5190

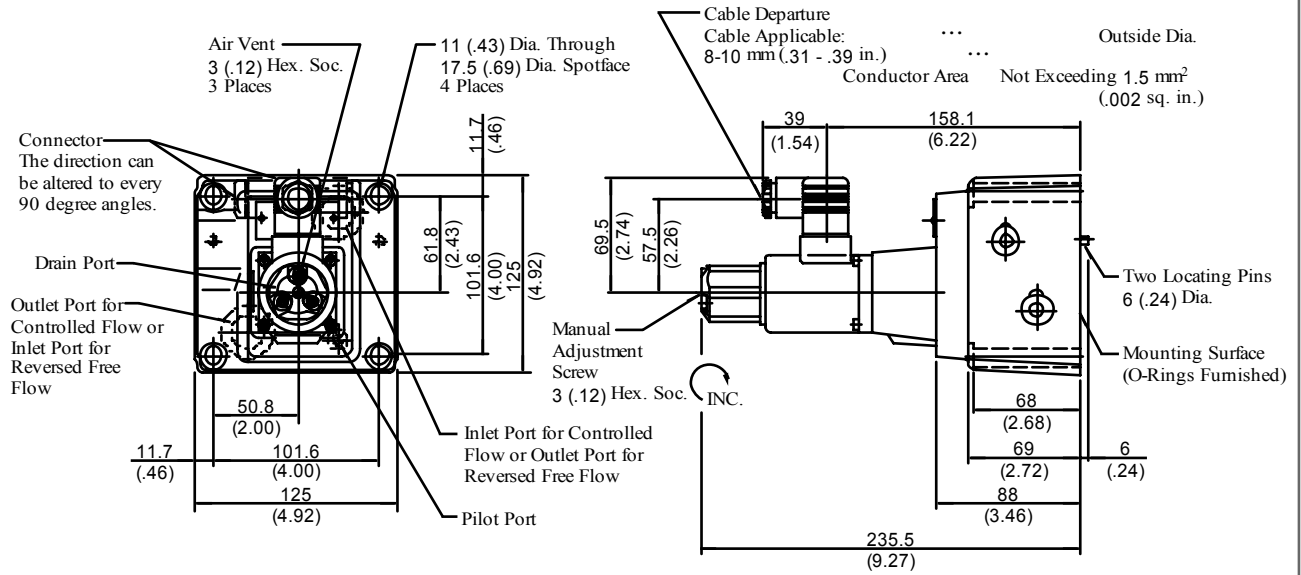

DIMENSIONS IN
MILLIMETRES (INCHES)

EFG
EFCG-06-250*-51/5190

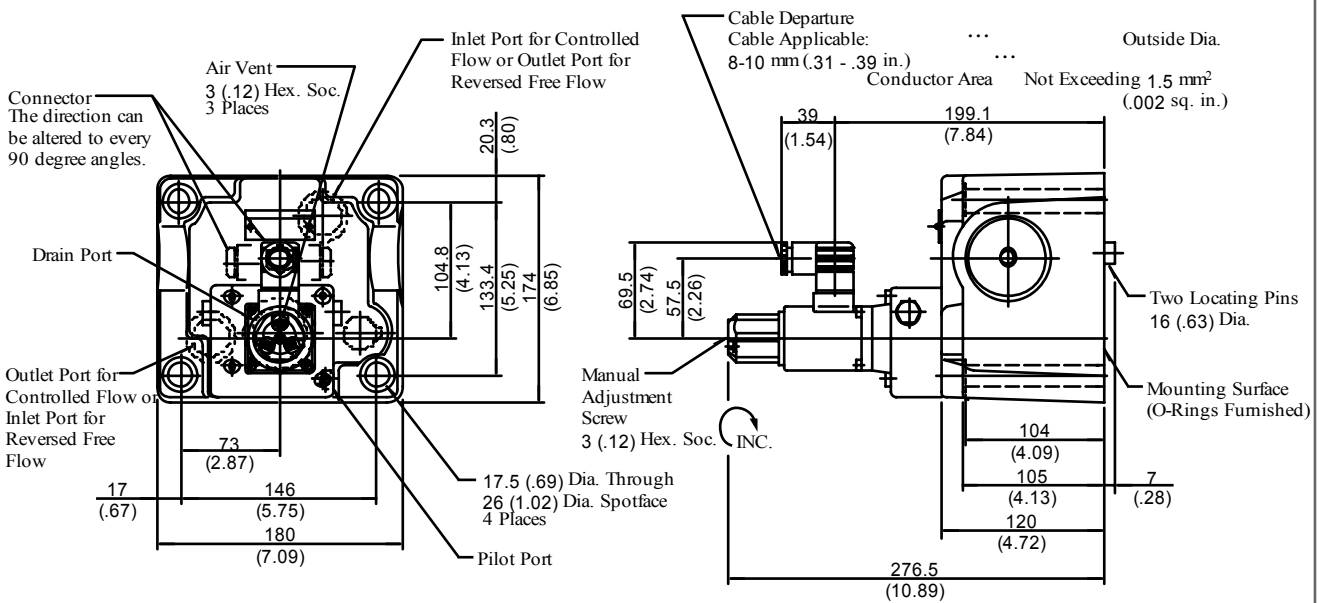

Installation Drawing

■ **Sub-plate**

EFGM-03Y, 03Z-30/3080/3090

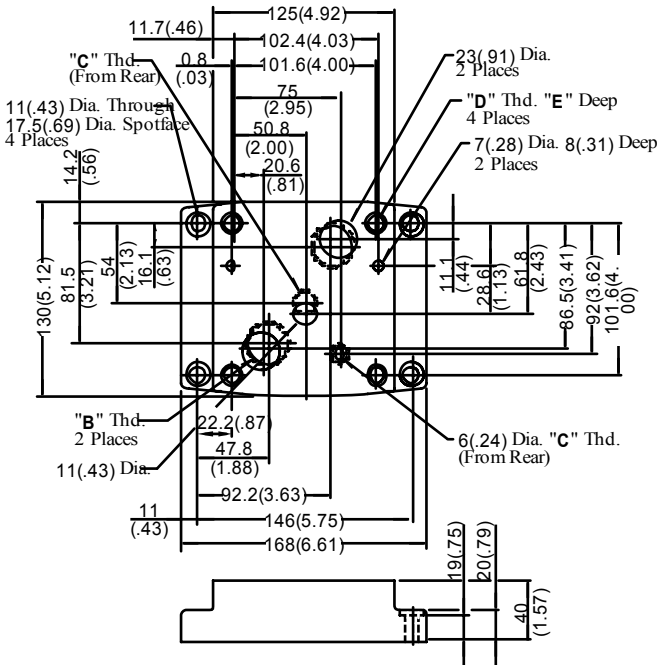

Sub-plate Model Numbers	Thread Size			E mm (in.)
	"B" Thd.	"C" Thd.	"D" Thd.	
EFGM-03Y-30	Rc 3/4	Rc 1/4	M10	18 (.71)
EFGM-03Z-30	Rc 1			
EFGM-03Y-3080	3/4 BSP.F	1/4 BSP.F		
EFGM-03Z-3080	1 BSP.F			
EFGM-03Y-3090	3/4 NPT	1/4 NPT	3/8-16 UNC	21 (.83)
EFGM-03Z-3090	1 NPT			

**DIMENSIONS IN
MILLIMETRES (INCHES)**

EFGM-06X, 06Y-30/3080/3090

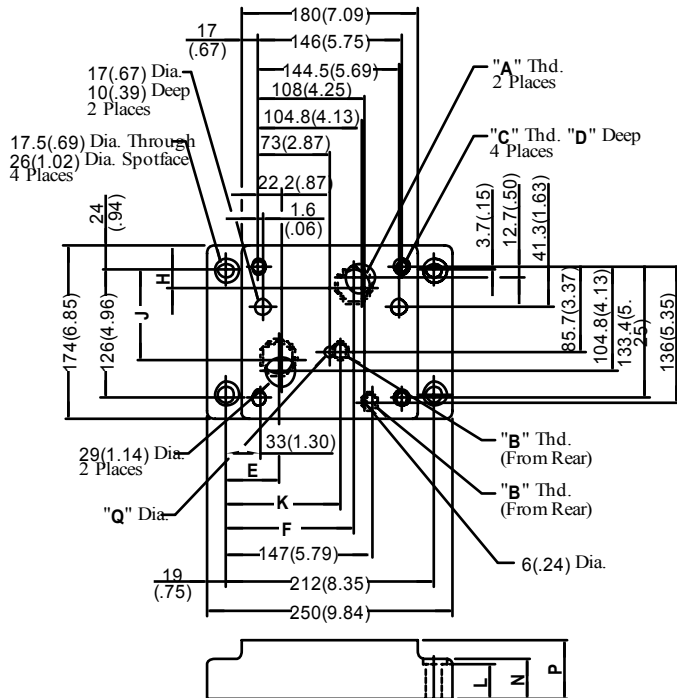

Sub-plate Model Numbers	Thread Size		
	"A" Thd.	"B" Thd.	"C" Thd.
EFGM-06X-30	Rc 1	Rc 3/8	M16
EFGM-06Y-30	Rc 1-1/4		
EFGM-06X-3080	1 BSP.F	3/8 BSP.F	
EFGM-06Y-3080	1-1/4 BSP.F		
EFGM-06X-3090	1 NPT	3/8 NPT	5/8-11 UNC
EFGM-06Y-3090	1-1/4 NPT		

Sub-plate Model Numbers	Dimensions mm (Inches)										
	D	E	F	H	J	K	L	N	P	Q	
EFGM-06X-30	30 (1.18)	55.2 (2.17)	137.8 (5.43)	14.3 (.56)	101.1 (3.98)	106 (4.17)	34 (1.34)	35 (1.38)	45 (1.77)	11 (.43)	
EFGM-06Y-30		52 (2.05)	132 (5.20)	19.3 (.76)	91.3 (3.59)		39 (1.54)	40 (1.57)	60 (2.36)		
EFGM-06X-3080		35 (1.38)	55.2 (2.17)	137.8 (5.43)	14.3 (.56)	101.1 (3.98)	116 (4.57)	34 (1.34)	35 (1.38)	45 (1.77)	15.2 (.60)
EFGM-06Y-3080			52 (2.05)	132 (5.20)	19.3 (.76)	91.3 (3.59)		39 (1.54)	40 (1.57)	60 (2.36)	15 (.59)
EFGM-06X-3090	35 (1.38)	55.2 (2.17)	137.8 (5.43)	14.3 (.56)	101.1 (3.98)	106 (4.17)	34 (1.34)	35 (1.38)	45 (1.77)	11 (.43)	
EFGM-06Y-3090		52 (2.05)	132 (5.20)	19.3 (.76)	91.3 (3.59)		39 (1.54)	40 (1.57)	60 (2.36)		

Typical Performance Characteristics

Input Current vs. Flow

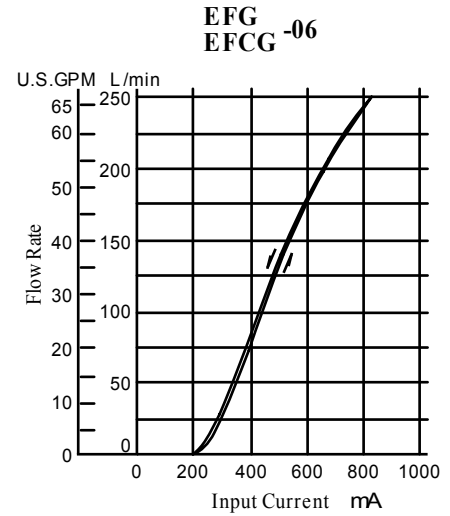
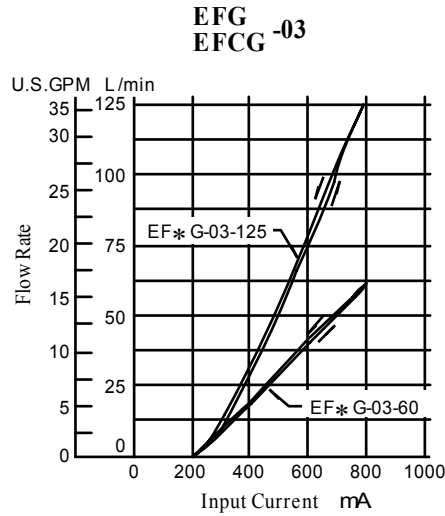

Step Response

These characteristics have been obtained by measuring on each valve. Therefore, they may vary according to a hydraulic circuit to be used.

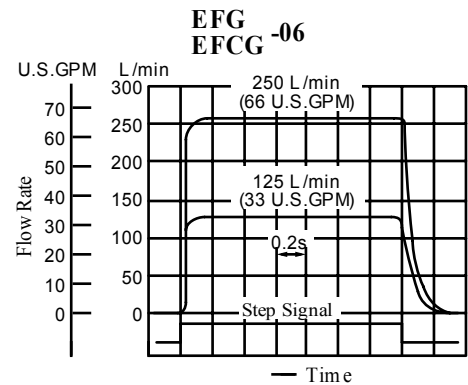
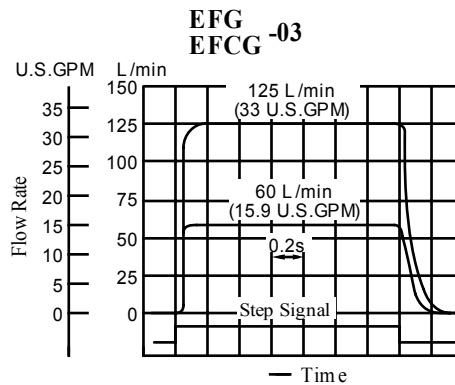

Frequency Response

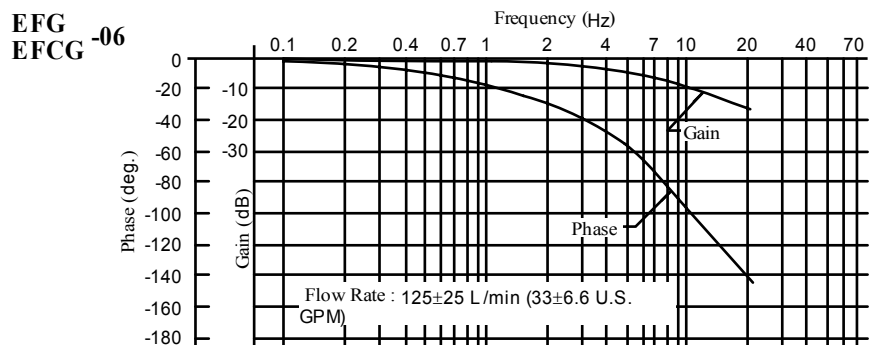
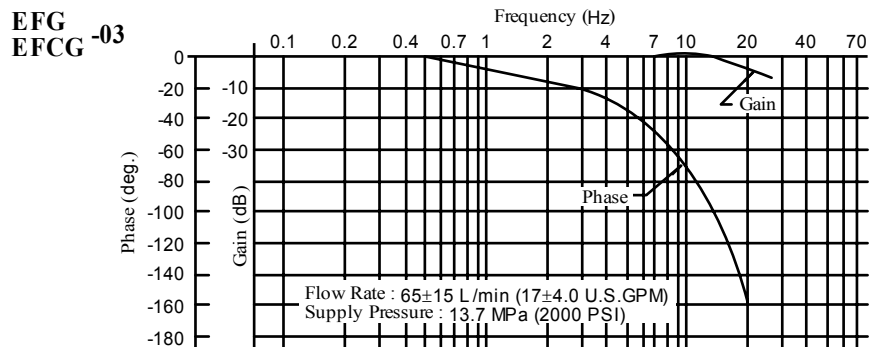

Typical Performance Characteristics

■ Viscosity vs. Flow

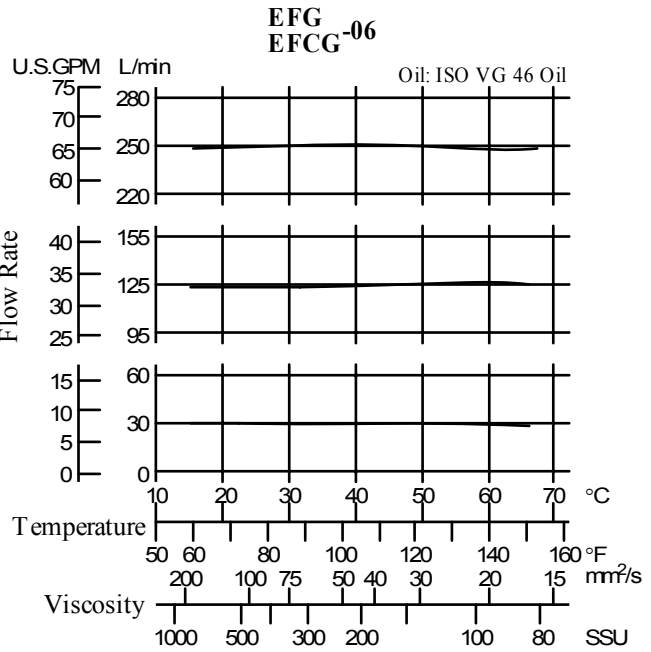
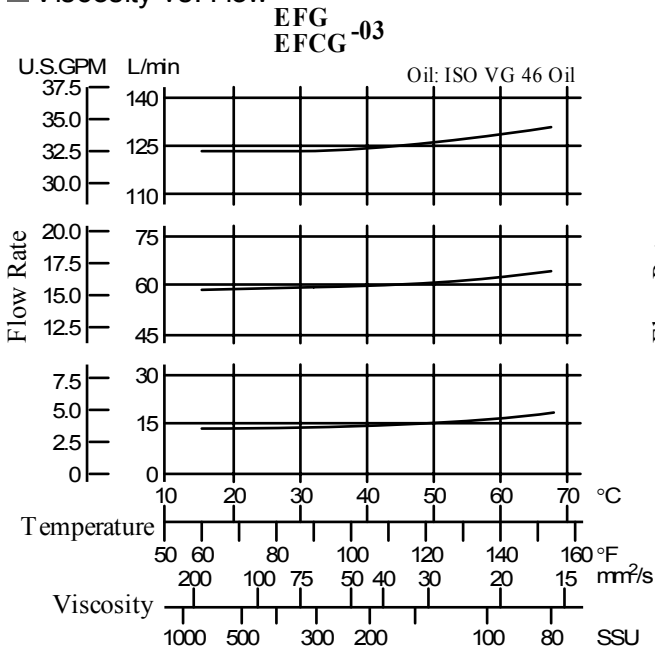

■ Differential Pressure vs. Metred Flow

EFG-03
EFCG-03

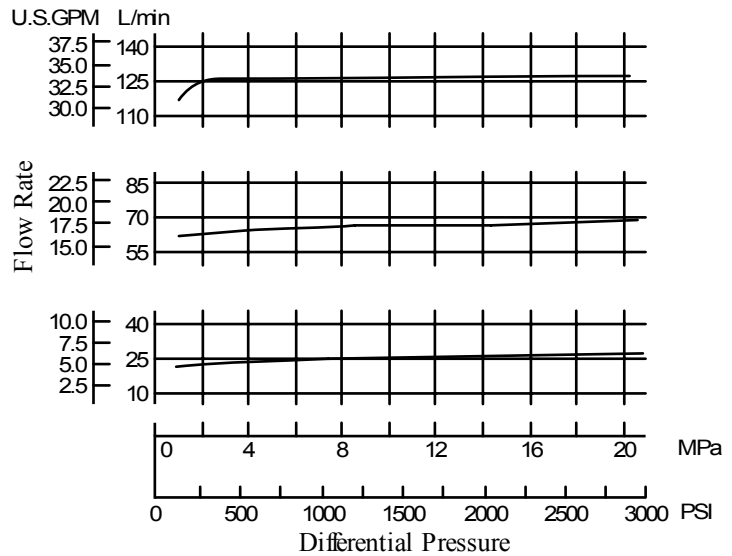

EFG-06
EFCG-06

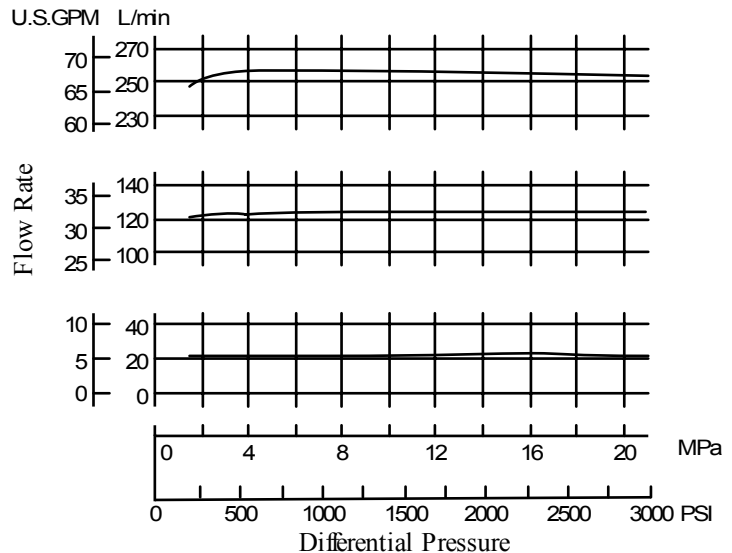

Spare Parts List

EFG
EFCG-03-*-*-51/5190

CAUTION

When making replacement of seals, please do it carefully after reading through the relevant instructions in the Operator's Manual.

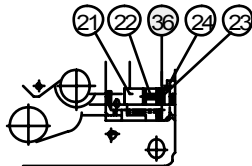
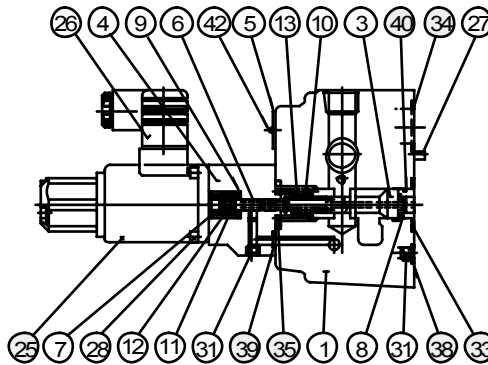
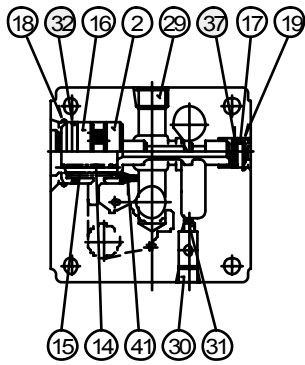

With Check Valve (EFCG-03)

List of Seal Kits

Model Numbers	Seal Kit Numbers
EFG-03-*-*-51*	KS-EFG-03-51
EFCG-03-*-*-51*	KS-EFCG-03-51

List of Seals and Solenoid Ass'y

Item	Name of Parts	Part Numbers	Qty.
25	Solenoid Ass'y	E318-Y06M1-28-61	1
32	O-Ring	SO-NB-G35	1
33	O-Ring	SO-NB-P28	1
34	O-Ring	SO-NB-P28	2
35	O-Ring	SO-NB-P26	1
36	O-Ring	SO-NB-P16	1
37	O-Ring	SO-NB-P14	1
38	O-Ring	SO-NB-P9	1
39	O-Ring	SO-NB-P6	2
40	O-Ring	SO-NA-A016	1

Note: The connector assembly GDM-211-B-11 (Item 26) is not included in the solenoid assembly.

Note: When ordering seals, please specify the seal kit number from the table right. In addition to the above o-rings, o-rings for solenoid ass'y is included in the seal kit. For the detail of the solenoid ass'y seals, see the Catalogue No. Pub. EC-1302.

EFG
EFCG-06-250-*-*-51/5190

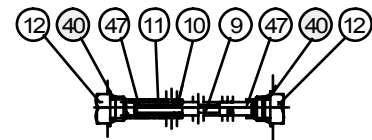
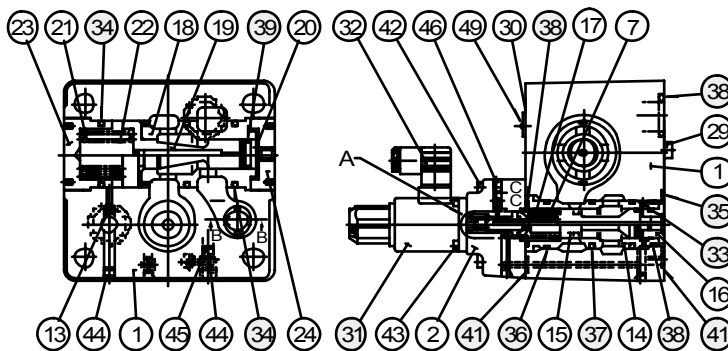

Detail of Section C-C

List of Seal Kits

Model Numbers	Seal Kit Numbers
EFG-06-250-*-*-51*	KS-EFG-06-51
EFCG-06-250-*-*-51*	KS-EFCG-06-51

With Check Valve (EFCG-06)

List of Seals and Solenoid Ass'y

Item	Name of Parts	Part Numbers	Qty.
31	Solenoid Ass'y	E318-Y06M1-28-61	1
33	O-Ring	SO-NA-P21	1
34	O-Ring	SO-NB-P50	3
35	O-Ring	SO-NB-P46	1
36	O-Ring	SO-NB-P36	1
37	O-Ring	SO-NB-P34	2
38	O-Ring	SO-NB-P32	4
39	O-Ring	SO-NA-P21	1*
40	O-Ring	SO-NB-P10	2
41	O-Ring	SO-NB-P9	3

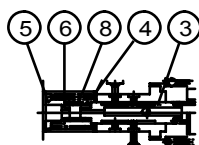

Detail of "A"

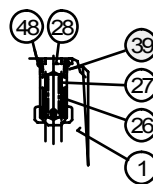

Section B-B

Note: The connector assembly GDM-211-B-11 (Item 32) is not included in the solenoid assembly.

Note: When ordering seals, please specify the seal kit number from the table right. In addition to the above o-rings, o-rings for solenoid ass'y is included in the seal kit. For the detail of the solenoid ass'y seals, see the Catalogue No. Pub. EC-1302.

* Two O-rings are required for the EFCG.

■ **Interchangeability between Current and New Design**

EFG/EFCG-03/06 series valves have changed model from 50 to 51 design in line with the model change of solenoid ass'y (E318).

● **Specifications and characteristics**

No change in specifications and characteristics between current and new design.

● **Mounting Interchangeability**

There is an interchangeability in the mounting dimensions between current and new design, however, note that because of improvements made on the solenoids, the overall shapes have been changed as shown below.

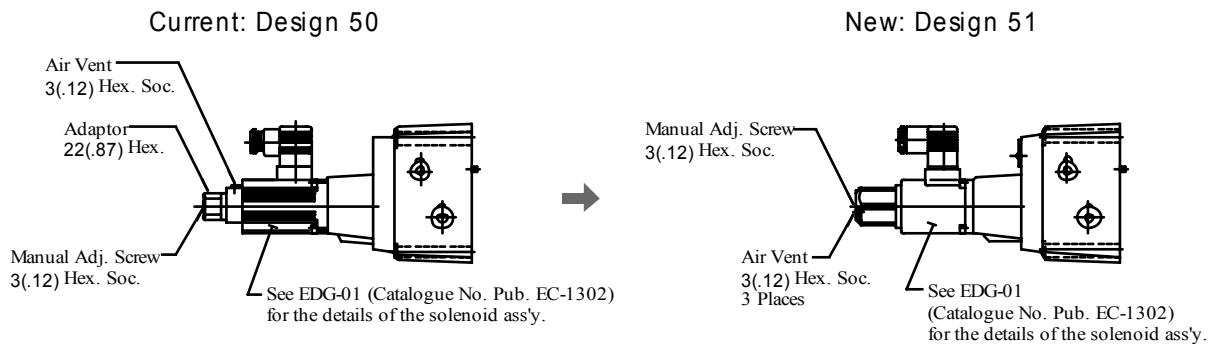

**DIMENSIONS IN
MILLIMETRES (INCHES)**



Specifications

Model No.		EFBG-03 -125-* -17*	EFBG-06 -250-* -17*	EFBG-10 -500-* -17*
Description				
Max. Operating Pressure MPa (PSI)		24.5 (3550)	24.5 (3550)	24.5 (3550)
Max. Flow L/m in (U.S.GPM)		125 (33)	250 (66)	500 (132)
Metred Flow Adjustment Range L/m in (U.S.GPM)		1-125 (.26-33)	2.5-250 (.66-66)	5-500 (1.32-132)
Flow Controls	Rated Current	600 mA	580 mA	700 mA
	Coil Resistance	43.5 Ω	43.5 Ω	43.5 Ω
	Differential Pressure MPa (PSI)	0.6 (85)	0.7 (100)	0.9 (130)
	Hysteresis	Less than 7%	Less than 7%	Less than 7%
	Repeatability	Less than 1%	Less than 1%	Less than 1%
	Pressure Controls *1	Pres. Adj. Range MPa (PSI) *2	C : 1.4-13.7 (205-2000) H : 1.4-20.6 (205-3000)	C : 1.5-13.7 (220-2000) H : 1.5-20.6 (220-3000)
Pressure Controls *1	Rated Current	C : 750 mA H : 750 mA	C : 690 mA H : 730 mA	C : 690 mA H : 690 mA
	Coil Resistance	10 Ω	10 Ω	10 Ω
	Hysteresis	Less than 3%	Less than 3%	Less than 3%
	Repeatability	Less than 1%	Less than 1%	Less than 1%
	Approx. Mass kg (lbs.)	Refer to page 24 to 26		

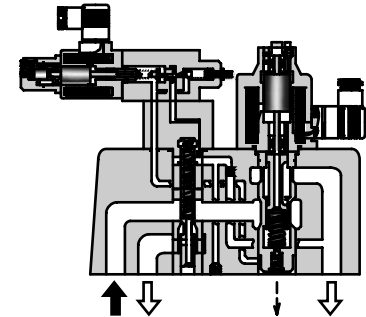
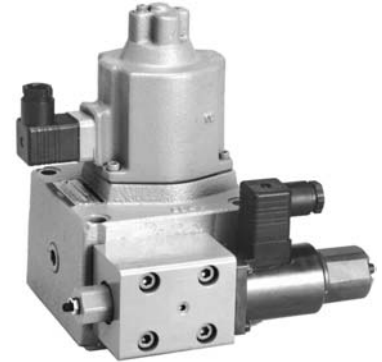

1. The specifications for pressure controls are applied to models with proportional pilot relief valve. (Ex. EFBG-03-125-C- -17)

*2. The maximum pressure adjustment range of the models without proportional pilot relief valves is 24.5 MPa (3550 PSI).

Model Number Designation

EFB	G	-03	-125	-C	-17	*
Series Number	Type of Mounting	Valve Size	Max. Metred Flow L/m in (U.S.GPM)	Proportional Pilot Relief Valve Pressure Adjustment Range	Design Number	Design Standards
EFB : Proportional Electro-Hydraulic Flow Control and Relief Valve	G : Sub-plate Mounting	03	125 : 125 (33)	C, H : See Specifications None : Without Proportional Pilot Relief Valve	17	Refer to ★
		06	250 : 250 (66)		17	
		10	500 : 500 (132)		17	

★ Design Standards: None Japanese Standard "JIS" and European Design Standard 90 N. American Design Standard

Graphic Symbols

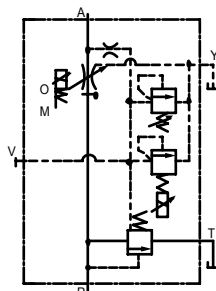

With Proportional Pilot Relief Valve

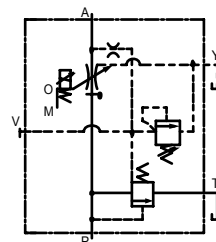

Without Proportional Pilot Relief Valve

■ **Attachment**

● **Mounting Bolts**

Valve Model Numbers	Socket Head Cap Screw		Qty.
	Japanese Std. "JIS" and European Design Std.	N. American Design Std.	
EFBG-03	M10 × 100 Lg.	3/8-16 UNC × 4 Lg.	4
EFBG-06	M16 × 130 Lg.	5/8-11 UNC × 5 Lg.	4
EFBG-10	M20 × 130 Lg.	3/4-10 UNC × 5 Lg.	4

■ **Applicable Power Amplifiers**

For stable performance, it is recommended that Yuken's applicable power amplifiers be used (for details see the Catalogue No. Pub. EC-1305).

Model Numbers	Power Amplifier Model Numbers	
	For Flow Control	For Pres. Control
EFBG-03-125-17/1790 EFBG-06-250-17/1790 EFBG-10-500-17/1790	AME-D-S-*-32 AME-DF-S-*-22 AME-T-S-*-22	—
EFBG-06- ⁰³ *- ^C _H -17/1790 10	AME-D2-H1-*-12	

■ **Sub-plate**

Valve Model Numbers	Japanese Standard "JIS"		European Design Standard		N. American Design Standard		Approx. Mass kg (lbs.)
	Sub-plate Model Numbers	Thread Size	Sub-plate Model Numbers	Thread Size	Sub-plate Model Numbers	Thread Size	
EFBG-03	EFBGM-03Y-10	Rc 3/4	EFBGM-03Y-1080	3/4 BSP.F	EFBGM-03Y-1090	3/4 NPT	6 (13.2)
	EFBGM-03Z-10	Rc 1	EFBGM-03Z-1080	1 BSP.F	EFBGM-03Z-1090	1 NPT	
EFBG-06	EFBGM-06X-10	Rc 1	EFBGM-06X-1080	1 BSP.F	EFBGM-06X-1090	1 NPT	12.5 (27.6)
	EFBGM-06Y-10	Rc 1-1/4	EFBGM-06Y-1080	1-1/4 BSP.F	EFBGM-06Y-1090	1-1/4 NPT	16 (35.3)
EFBG-10	EFBGM-10Y-10 ^π	1-1/2, 2 Flange Mounting	EFBGM-10Y-1080 [*]	1-1/2, 2 Flange Mounting	EFBGM-10Y-1090 [*]	1-1/2, 2 Flange Mounting	37 (81.6)

● Sub-plates are available. Specify the sub-plate model number from the table above. When sub-plates are not used, the mounting surface should have a good machined finish.

★ When ordering the EFBGM-10Y, see Type F3 Pipe Flange Kits on the Catalogue No. Pub. EC-3001 and order an appropriate pipe flange kit also.

■ **Instructions**

● **Drain Back Pressure**

Check that the drain back pressure does not exceed 0.2 MPa (29 PSI).

● **When Relief Valve Passing Flow Rate is Low in Pressure Control State**

To avoid preselected pressure instability, use a passing flow rate of 10 L/min (2.6 U.S.GPM) or higher for nominal sizes 03 and 06 or 15 L/min (4.0 U.S.GPM) or higher for nominal size 10.

Further, check that the tank-line back pressure does not exceed 0.5 MPa (70 PSI).

● **Safety Valve Pressure Setting**

The pressure of the safety valve is preset at the value equal to the upper limit of the pressure adjustment range plus 2 MPa (290 PSI). Please adjust the pressure of the valve so preset to meet the pressure to be used actually.

To lower the pressure setting, turn the safety valve pressure adjustment screw anti-clockwise. After adjustment, be sure to tighten the lock nut.

Installation Drawing

Models with Proportional Pilot Relief Valve

EFBG-03-125-^C_H 17/1790

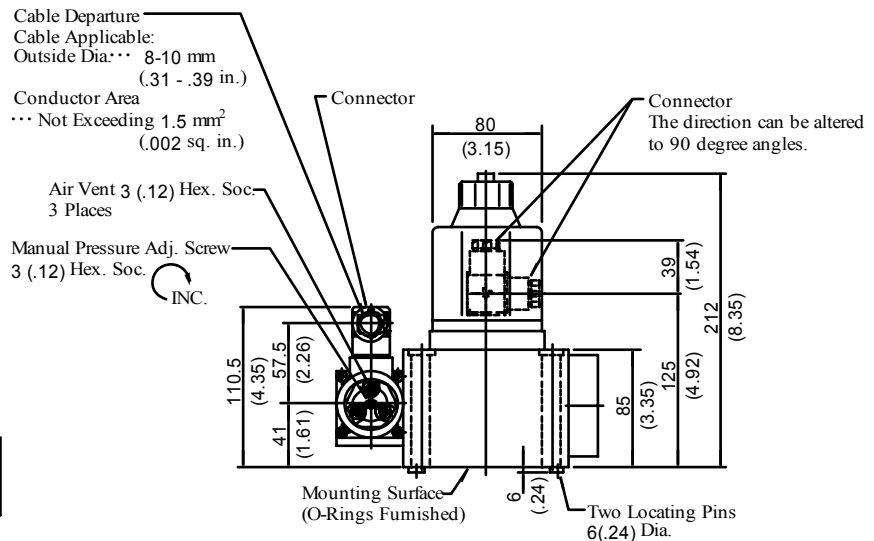
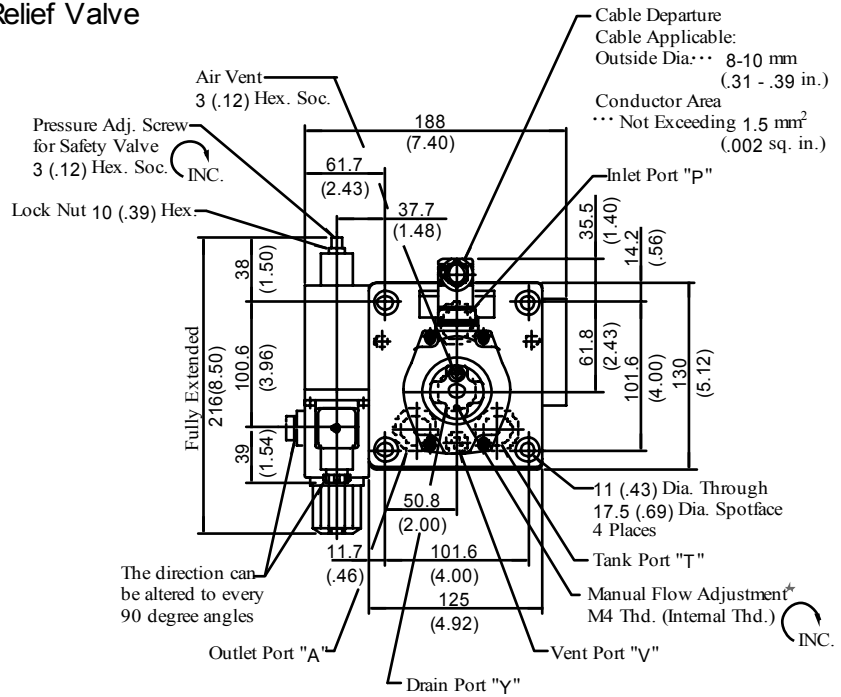

DIMENSIONS IN
MILLIMETRES (INCHES)

★ Manual flow adjustment can be done by screwing for example an × M4 20L screw in the M4 thread or pushing in a rod etc.

Approx. Mass 16 kg
(35.3 lbs.)

Models without Proportional Pilot Relief Valve

EFBG-03-125-17/1790

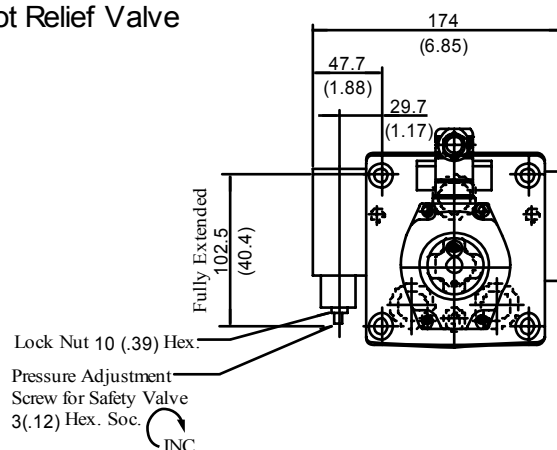

Approx. Mass 14 kg
(30.9 lbs.)

• For other dimensions, please refer to the models with proportional pilot relief valve.

Installation Drawing

Models with Proportional Pilot Relief Valve

EFBG-06-250-^C_H17/1790

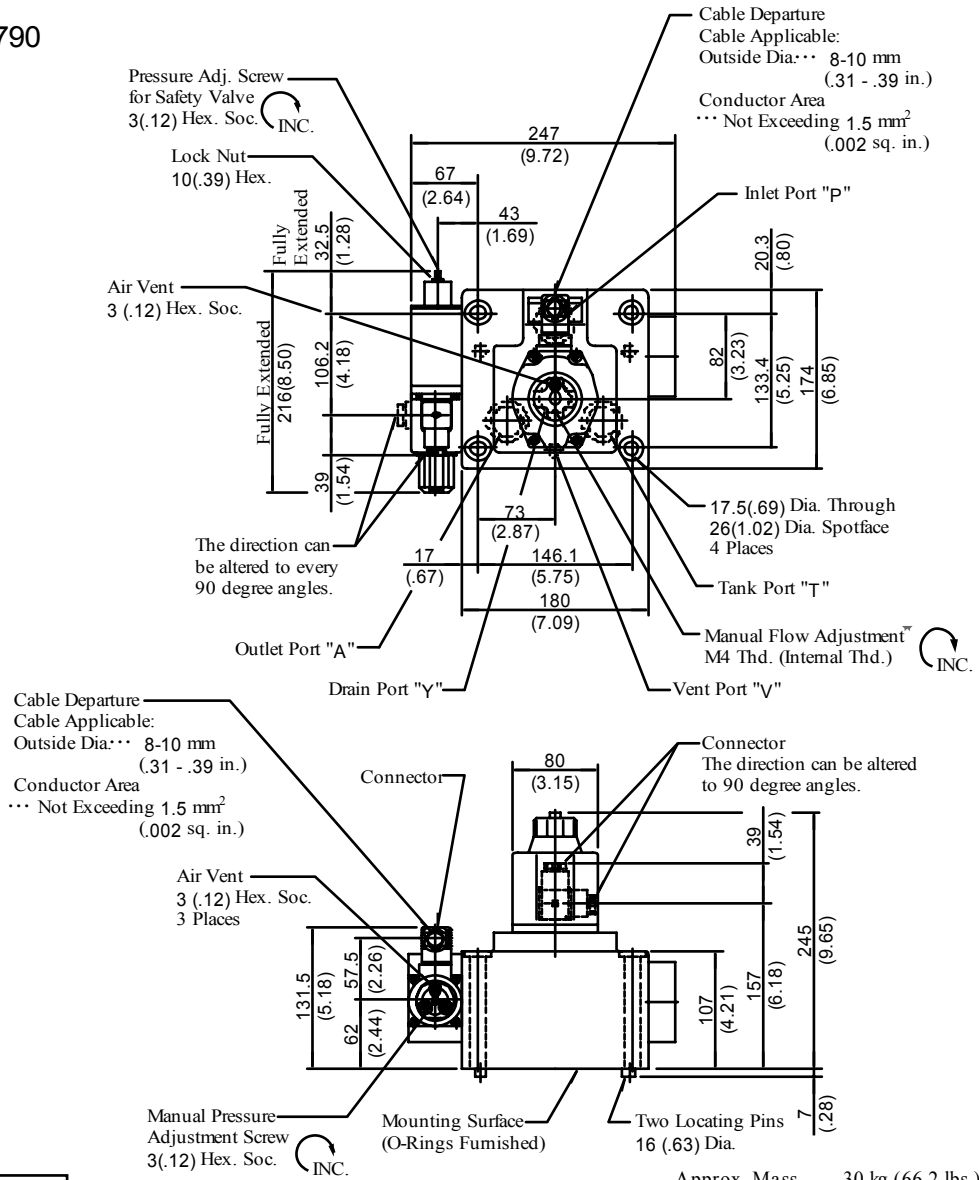

**DIMENSIONS IN
MILLIMETRES (INCHES)**

★ Manual flow adjustment can be done by screwing for example an M4 20L screw in the M4 thread or pushing in a rod etc. there.

Approx. Mass 30 kg (66.2 lbs.)

Models without Proportional Pilot Relief Valve

EFBG-06-250-17/1790

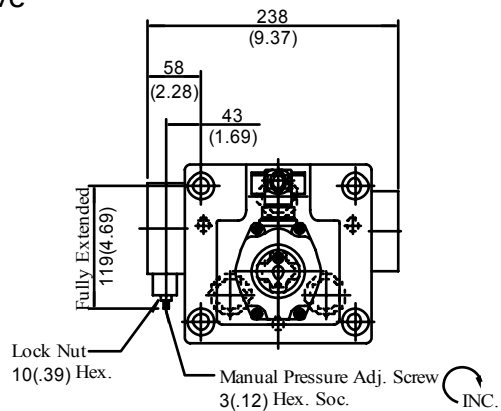

Approx. Mass 28 kg (61.7 lbs.)

• For other dimensions, please refer to the models with Proportional Pilot Relief Valve.

Installation Drawing

Models with Proportional Pilot Relief Valve

EFBG-10-500-^C_H-17/1790

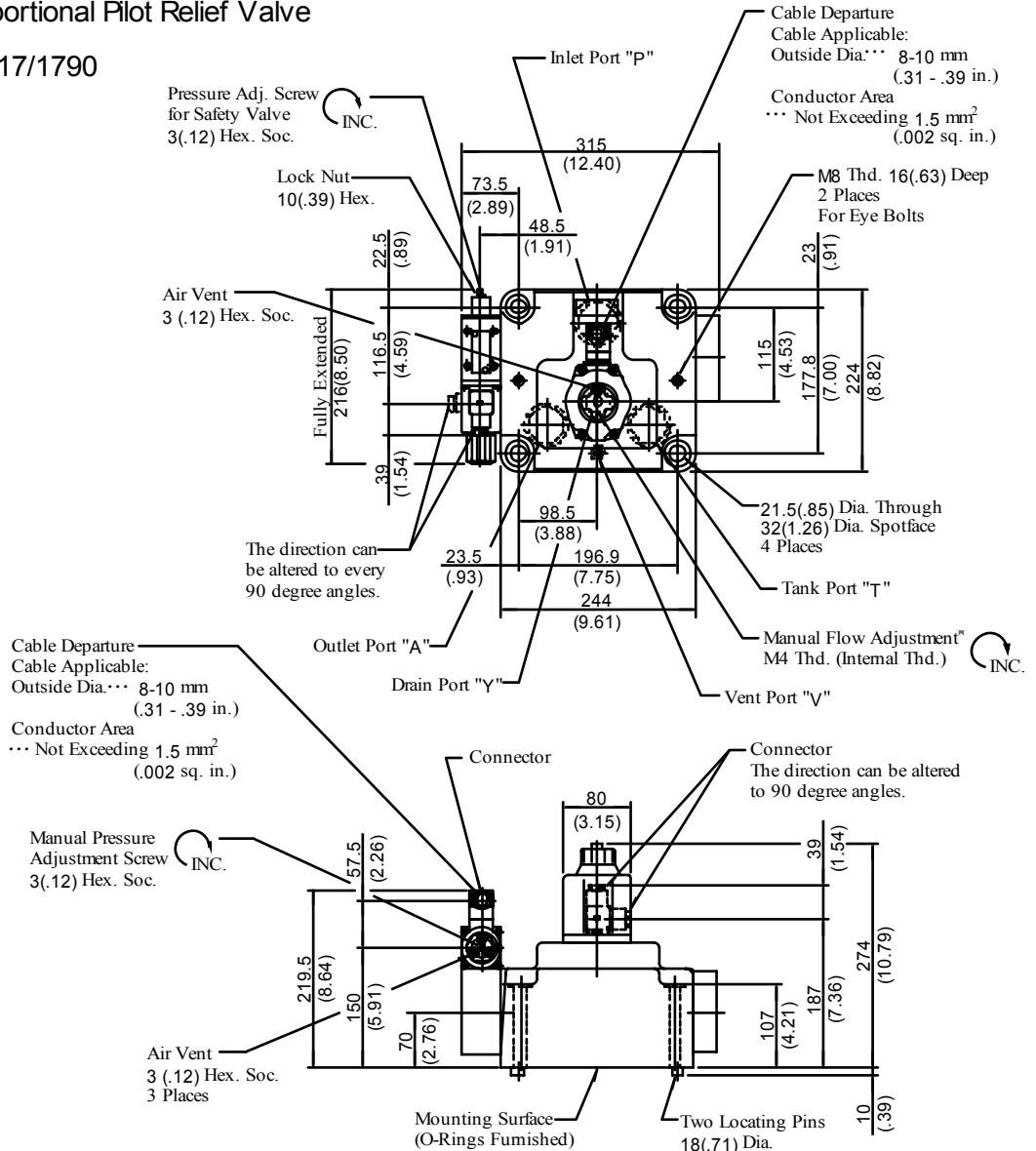

Approx. Mass 60 kg (132 lbs.)

**DIMENSIONS IN
MILLIMETRES (INCHES)**

★ Manual adjustment can be done by screwing for example an M4 20 L screw in the M4 thread or pushing in a rod etc. there.

Models without Proportional Pilot Relief Valve

EFBG-10-500-17/1790

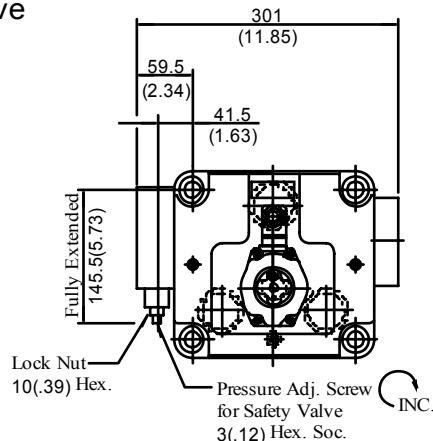

Approx. Mass 58 kg (128 lbs.)

● For other dimensions, please refer to the models with Proportional Pilot Relief Valve.

■ Sub-plate

EFBGM-03Y/03Z-10/1080/1090

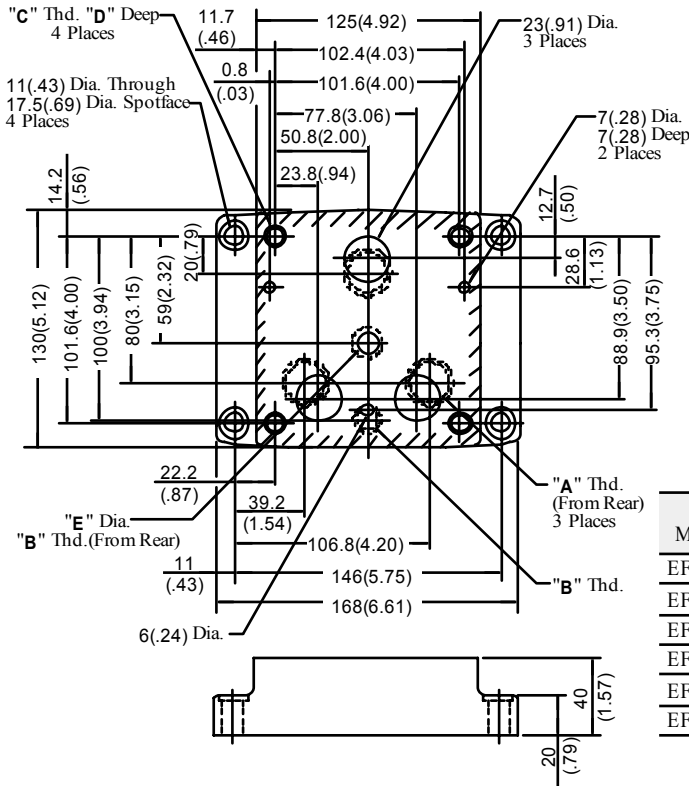

Sub-plate Model Numbers	Thread Size			mm (in.)	
	"A" Thd.	"B" Thd.	"C" Thd.	D	E
EFBGM-03Y-10	Rc 3/4	Rc 1/4	M10	18 (.71)	11 (.43)
EFBGM-03Z-10	Rc 1				11.7 (.46)
EFBGM-03Y-1080	3/4 BSP.F	1/4 BSP.F			11 (.43)
EFBGM-03Z-1080	1 BSP.F				11.7 (.46)
EFBGM-03Y-1090	3/4 NPT	1/4 NPT	3/8-16 UNC	21 (.83)	11 (.43)
EFBGM-03Z-1090	1 NPT				11 (.43)

DIMENSIONS IN
MILLIMETRES (INCHES)

EFBGM-06X/06Y-10/1080/1090

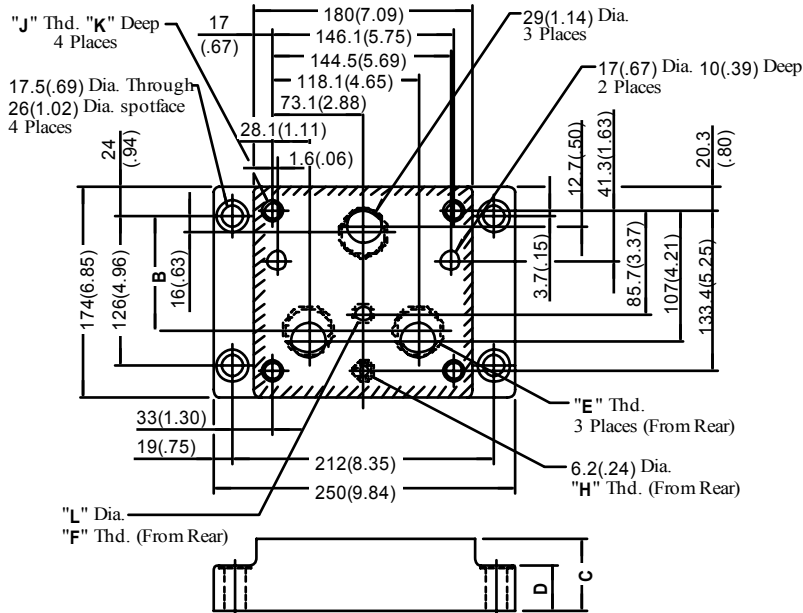

Sub-plate Model No.	Dimensions mm (in.)		
	B	C	D
EFBGM-06X	103.3 (4.07)	45 (1.77)	35 (1.38)
EFBGM-06Y	95 (3.74)	60 (2.36)	40 (1.54)

Sub-plate Model No.	Thread Size				mm (in.)	
	"E" Thd.	"F" Thd.	"H" Thd.	"J" Thd.	K	L
EFBGM-06X-10	Rc 1	Rc 3/8	Rc 1/4	M 16	30	14
EFBGM-06Y-10	Rc 1-1/4				(1.18)	(.55)
EFBGM-06X-1080	1 BSP.F	3/8 BSP.F	1/4 BSP.F	M 16	30	15.2
EFBGM-06Y-1080	1-1/4 BSP.F				(1.18)	(.60)
EFBGM-06X-1090	1 NPT	3/8 NPT	1/4 NPT	5/8-11 UNC	35	14
EFBGM-06Y-1090	1-1/4 NPT				(1.38)	(.55)

EFBGM-10Y-10/1080/1090

DIMENSIONS IN
MILLIMETRES (INCHES)

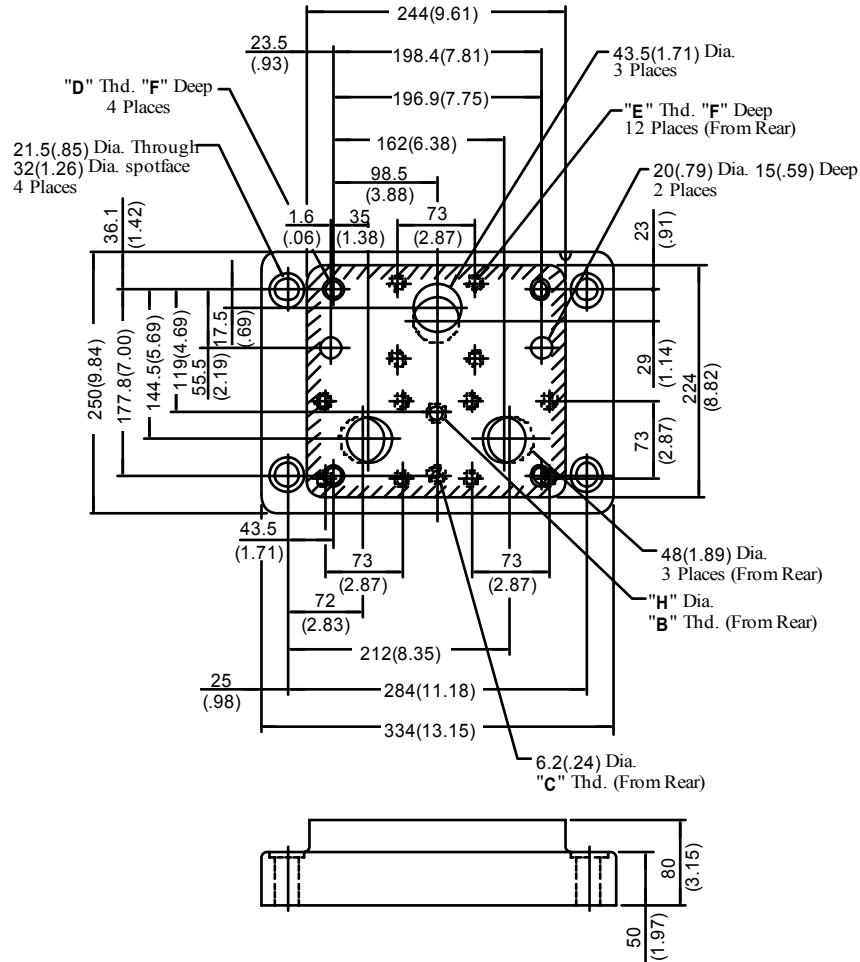

Sub-plate Model No.	Thread Size			
	"B" Thd.	"C" Thd.	"D" Thd.	"E" Thd.
EFBGM-10Y-10	Rc 3/8	Rc 1/4	M20	M16
EFBGM-10Y-1080	3/8 BSP.F	1/4 BSP.F		
EFBGM-10Y-1090	3/8 NPT	1/4 NPT	3/4-10 UNC	5/8-11 UNC

Sub-plate Model No.	mm (in.)	
	F	H
EFBGM-10Y-10	32 (1.26)	14 (.55)
EFBGM-10Y-1080	32 (1.26)	15.2 (.60)
EFBGM-10Y-1090	34 (1.34)	14 (.55)

Typical Performance Characteristics

■ Step Response

These characteristics have been obtained by measuring on each valve. Therefore, they may vary according to a hydraulic circuit to be used.

● Flow Controls

EFBG-03

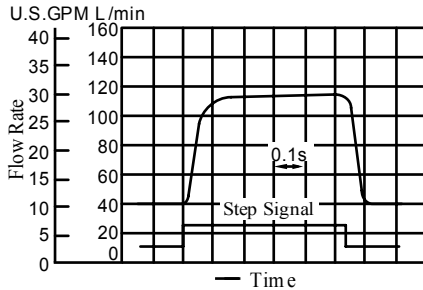

EFBG-06

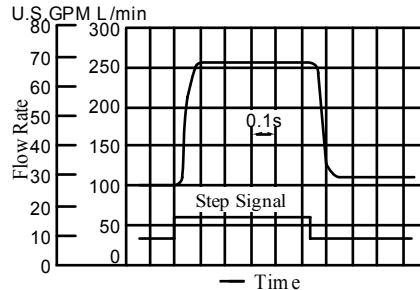

EFBG-10

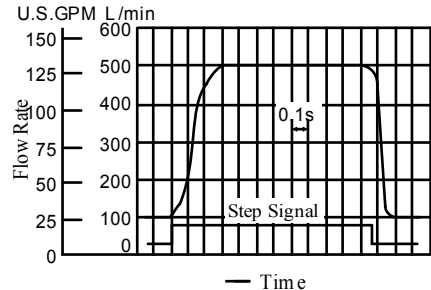

● Pressure Controls

EFBG-03

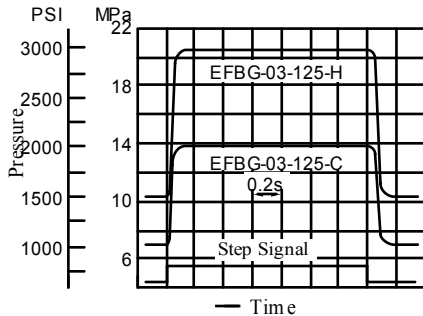

EFBG-06

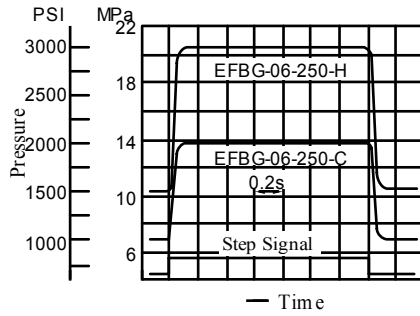

EFBG-10

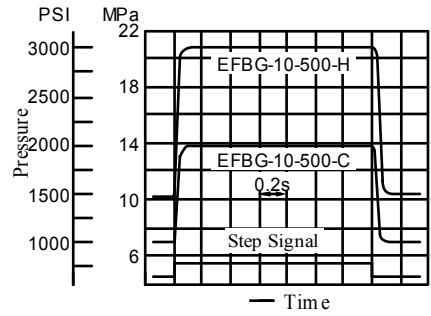

■ Input Current vs. Flow

EFBG-03

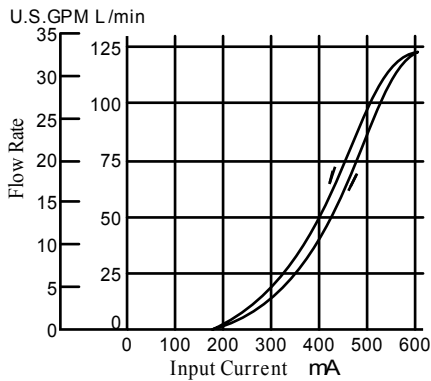

EFBG-06

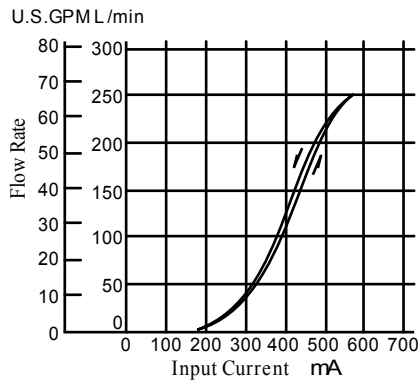

EFBG-10

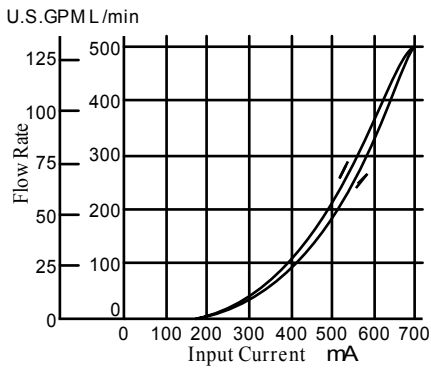

■ Input Current vs. Pressure

EFBG-03

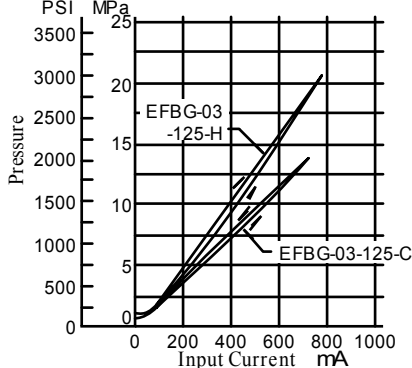

EFBG-06

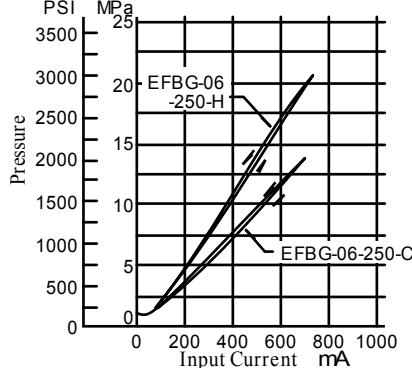

EFBG-10

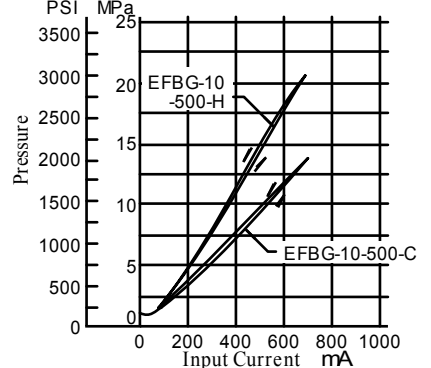

Spare Parts List

EFBG-03-125-*-17/1790
EFBG-06-250-*-17/1790

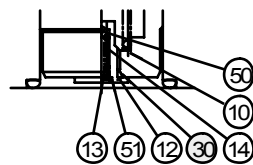
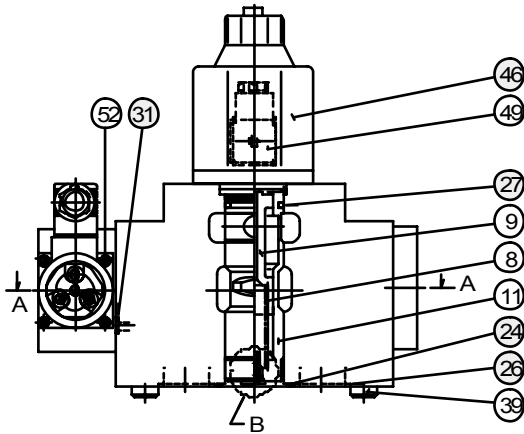

Detail of "B"

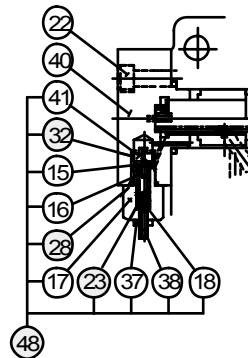
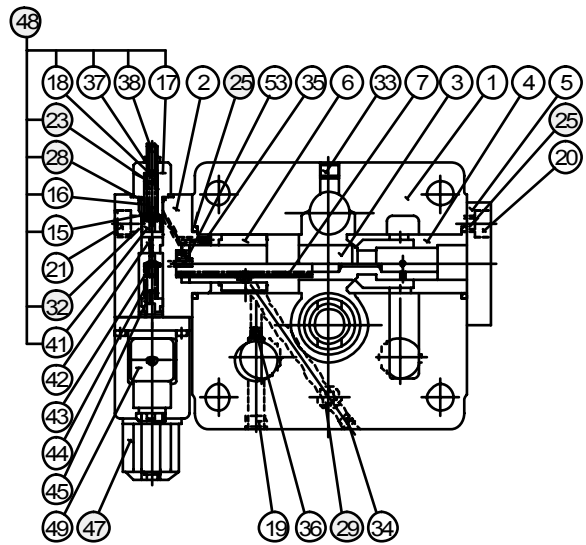

Without Proportional
Pilot Relief Valve

Section A-A

● List of Seals

Item	Name of Parts	Part Numbers		Qty.
		EFBG-03	EFBG-06	
23	O-Ring	SO-NA-P6	SO-NA-P6	1
24	O-Ring	SO-NB-G30	SO-NB-P44	1
25	O-Ring	SO-NB-P32	SO-NB-P42	2
26	O-Ring	SO-NB-P28	SO-NB-P32	3
27	O-Ring	—	SO-NB-P34	1
28	O-Ring	SO-NB-P14	SO-NB-P14	1
29	O-Ring	SO-NB-P11	SO-NB-P11	1
30	O-Ring	—	SO-NA-P10	1
31	O-Ring	SO-NB-P9	SO-NB-P9	1
32	O-Ring	SO-NB-A013	SO-NB-A013	1

⚠ CAUTION

When making replacement of seals, please do it carefully after reading through the relevant instructions in the Operator's Manual.

● List of Seal Kits

Model Numbers	Seal Kit Numbers
EFBG-03-125-17*	KS-EFBG-03-17
EFBG-03-125-C/H-17*	KS-EFBG-03-C-17
EFBG-06-250-17*	KS-EFBG-06-17
EFBG-06-250-C/H-17*	KS-EFBG-06-C-17

● Solenoid Ass'y and Safety valves

Valve Model Numbers	④7 Solenoid Ass'y Model No.	④6 Solenoid Ass'y Model No.	④8 Safety Valve Model No.
EFBG-03-125-C/H-17/1790	E318-Y06M2-05-61	E321-45-20	SB1094-2002
EFBG-06-250-C/H-17/1790			
EFBG-03-125-17/1790 EFBG-06-250-17/1790	—		

Note: The connector assembly GDM-211-B-11 is not included in the solenoid assembly.

When ordering seals, please specify the seal kit number from the table above.

In addition to the above o-rings, o-rings for solenoid ass'y ④6 and ④7 are included in the seal kit.

For the details of seals for solenoid ass'y ④6, see page 12 and for solenoid ass'y ④7 see Catalogue No. Pub. EC-1302.

Spare Parts List

EFBG-10-500-* -17/1790

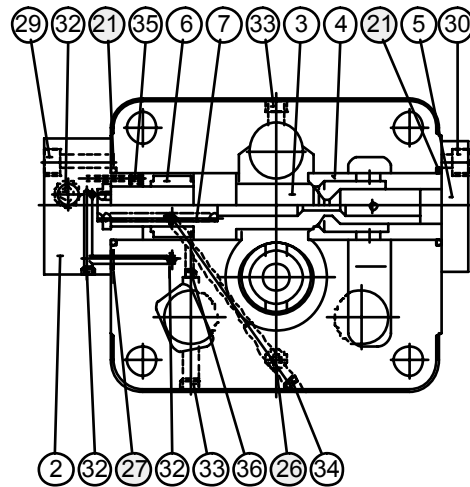
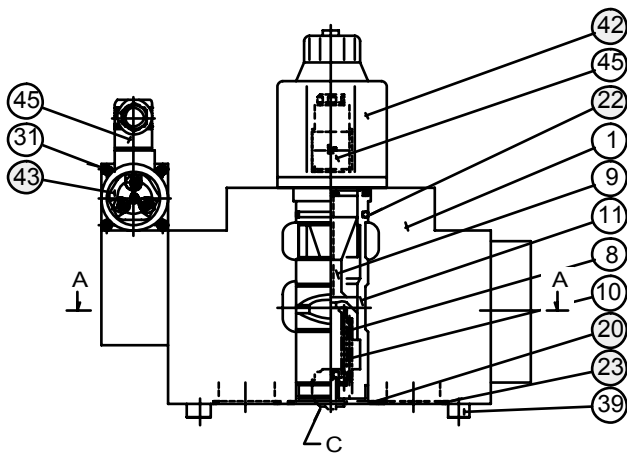

Section A-A

●Detail of Safety Valve
(Item 44)

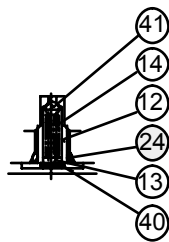

Detail of "C"

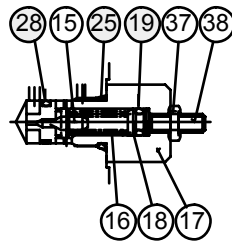

Section B-B

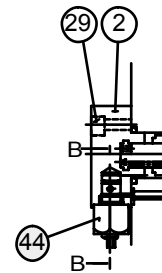

Without Proportional
Pilot Relief Valve

● List of Seals and Solenoid Ass'y

Item	Name of Parts	Part Numbers	Qty.
19	O-Ring	SO-NA-P6	1
20	O-Ring	SO-NB-G60	1
21	O-Ring	SO-NB-G55	2
22	O-Ring	SO-NB-P50	1
23	O-Ring	SO-NB-P48	3
24	O-Ring	SO-NA-P10	1
25	O-Ring	SO-NB-P14	1
26	O-Ring	SO-NB-P11	1
27	O-Ring	PO-NB-P11	1
28	O-Ring	SO-NB-A013	1
42	Solenoid Ass'y	E321-45-20	1

CAUTION

When making replacement of seals, please do it carefully after reading through the relevant instructions in the Operator's Manual.

● List of Seal Kits

Model Numbers	Seal Kit Numbers
EFBG-10-500-17*	KS-EFBG-10-17
EFBG-10-500-C/H-17*	KS-EFBG-10-C-17

Note: The connector assembly GDM-211-B-11 is not included in the solenoid assembly.

When ordering seals, please specify the seal kit number from the table right.

In addition to the above o-rings, o-rings for Pilot Valve and solenoid ass'y are included in the seal kit.

● Pilot Valves and Safety Valves

Valve Model Numbers	④ Proportional Pilot Relief Valve Model Numbers	④ Safety Valve Model Numbers
EFBG-10-500-17/1790	—	SB1094-2002
EFBG-10-500-C-17/1790	EDG-01V-C-1-P18T17-5103	—
EFBG-10-500-H-17/1790	EDG-01V-H-1-PNT13-5103	—

Note: Refer to Catalogue No.Pub.EC-1302 of the Proportional Pilot Relief Valve for details of the pilot valve.

Interchangeability between Current and New

■ Interchangeability between Current and New Design

Model changes have been made from 15 to 17-design in the EFBG-03/06 because of changes in the pilot valve building-method and in EFBG-10 because of model changes in the pilot valve.

● Specification and Characteristics

No changes in specifications and characteristics between current and new design.

● Interchangeability in Installation

● EFBG-03/06

There is an interchangeability in installation. However, the method of building in the pilot valve has been changed, bringing about changes in the appearance shapes and dimensions as shown below.

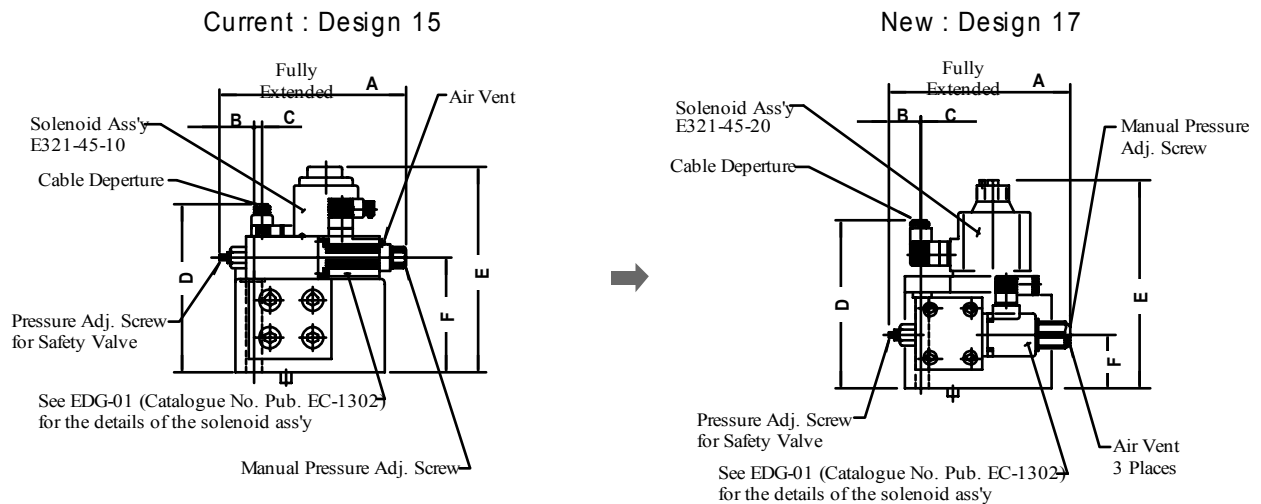

Model Numbers	A	B	C	D	E	F
(Current) EFBG-03-125-* -17/1790	216 (8.50)	38 (1.50)	23.5 (.93)	164 (6.46)	212 (8.35)	41 (1.61)
(New) EFBG-03-125-* -15/1590	217 (8.54)	47 (1.85)	25.7 (1.01)	164.3 (6.47)	213 (8.39)	101.5 (4.00)
(Current) EFBG-06-250-* -17/1790	216 (8.50)	32.5 (1.28)	3 (.12)	196 (7.72)	245 (9.65)	62 (2.44)
(New) EFBG-06-250-* -15/1590	217 (8.54)	39.5 (1.56)	5.5 (.22)	196.3 (7.73)	245 (9.65)	130 (5.12)

● EFBG-10

The mounting surface are interchangeable. Only the appearance shapes are different as follows;

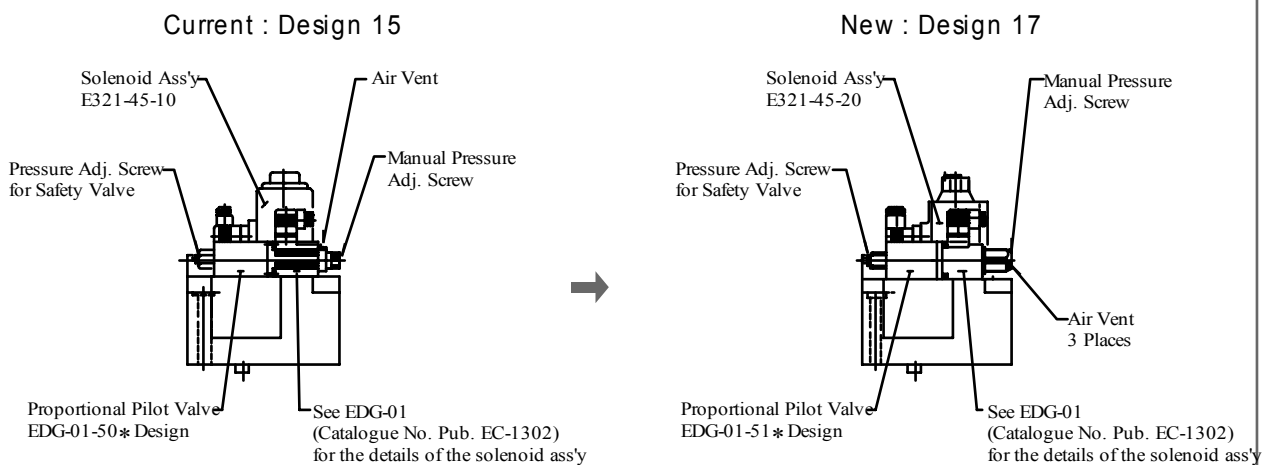

DIMENSIONS IN
MILLIMETRES (INCHES)

Specifications

Specifications

Model Numbers		EFBG-03 -125-*-*-61*	EFBG-06 -250-*-*-61*	EFBG-10 -500-*-*-51*
Description				
Max. Operating Pressure MPa (PSI)		24.5 (3550)	24.5 (3550)	24.5 (3550)
Max. Flow L/m in (U.S.GPM)		125 (33)	250 (66)	500 (132)
Metred Flow Adjustment Range L/m in (U.S.GPM)		1-125 (.26-33)	2.5-250 (.66-66)	5-500 (1.32-132)
Min. Pilot Pressure MPa (PSI)		1.5 (220)	1.5 (220)	1.5 (220)
Pilot Flow L/m in (U.S.GPM)		at Normal	1 (.26)	1 (.26)
		at Transition	3 (.79)	4 (1.06)
Flow Controls	Rated Current	800 mA	750 mA	900 mA
	Coil Resistance	10 Ω	10 Ω	10 Ω
	Differential Pressure MPa (PSI)	0.7 (100)	0.7 (100)	0.9 (130)
	Hysteresis	Less than 3%	Less than 3%	Less than 3%
	Repeatability	Less than 1%	Less than 1%	Less than 1%
Pressure Controls ^{★1}	Pres. Adj. Range MPa (PSI) ^{★2}	C : 1.4-15.7 (200-2275) H : 1.4-24.5 (200-3550)	C : 1.4-15.7 (200-2275) H : 1.4-24.5 (200-3550)	C : 1.5-15.7 (220-2275) H : 1.5-24.5 (220-3550)
	Rated Current	C : 890 mA H : 930 mA	C : 820 mA H : 880 mA	C : 800 mA H : 900 mA
	Coil Resistance	10 Ω	10 Ω	10 Ω
	Hysteresis	Less than 3%	Less than 3%	Less than 3%
	Repeatability	Less than 1%	Less than 1%	Less than 1%
	Approx. Mass kg (lbs.)	Refer to page 35 to 37		

★ 1. The specifications for pressure controls are applied to models with proportional pilot relief valve. (Ex. EFBG-03-125-C-*-61)

★ 2. The maximum pressure adjustment range of the models without proportional pilot relief valves is 24.5 MPa (3550 PSI).

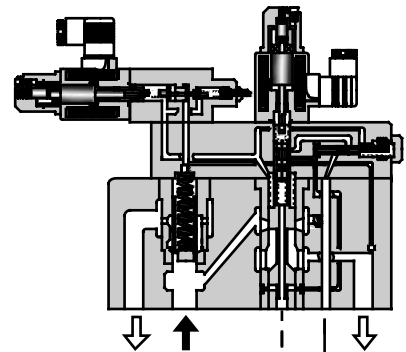

Graphic Symbols

With Proportional Pilot Relief Valve
External Pilot Internal Pilot

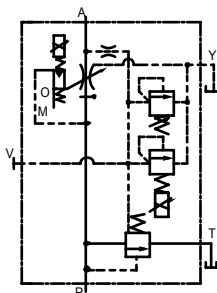

Without Proportional Pilot Relief Valve
External Pilot Internal Pilot

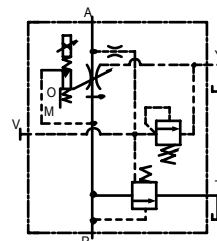

■ **Model Number Designation**

EFB	G	-03	-125	-C	-E	-61	*
Series Number	Type of Mounting	Valve Size	Max. Metred Flow L/min (U.S.GPM)	Proportional Pilot Relief Valve Pressure Adj. Range	Pilot Connection	Design Number	Design Standards
EFB: Proportional Electro-Hydraulic Flow Control and Relief Valve	G: Sub-plate Mounting	03	125: 125 (33)	C, H: See Specifications None: Without Proportional Pilot Relief Valve	None: Internal Pilot E: External Pilot	61	Refer to ★
		06	250: 250 (66)			61	
		10	500: 500 (132)			51	

★ Design Standards: None Japanese Standard "JIS" and European Design Standard
 90 N. American Design Standard

■ **Attachment**

● **Mounting Bolts**

Valve Model Numbers	Socket Head Cap Screw		Qty.
	Japanese Std. "JIS" and European Design Std.	N. American Design Std.	
EFBG-03	M10 × 65 Lg.	3/8-16 UNC × 2-1/2 Lg.	4
EFBG-06	M16 × 100 Lg.	5/8-11 UNC × 4 Lg.	4
EFBG-10	M20 × 130 Lg.	3/4-10 UNC × 5 Lg.	4

■ **Applicable Power Amplifiers**

For stable performance, it is recommended that Yuken's applicable power amplifiers be used (for details see Catalogue No. Pub. EC-1305).

Model Numbers	Power Amplifier Model Numbers	
	For Flow Control	For Pres. Control
EFBG-03-125-(E)-61/6190 EFBG-06-250-(E)-61/6190 EFBG-10-500-(E)-51/5190	AME-D-10-*-20 AMN-D-10 (For DC Power Supply)	—
EFBG-03-125-C/H-(E)-61/6190 EFBG-06-250-C/H-(E)-61/6190 EFBG-10-500-C/H-(E)-51/5190	AME-D2-1010-*-10	

■ **Sub-plate**

Valve Model Numbers	Japanese Standard "JIS"		European Design Standard		N. American Design Standard		Approx. Mass kg (lbs.)
	Sub-plate Model Numbers	Thread Size	Sub-plate Model Numbers	Thread Size	Sub-plate Model Numbers	Thread Size	
EFBG-03	EFBGM-03Y-20	Rc 3/4	EFBGM-03Y-2080	3/4 BSP.F	EFBGM-03Y-2090	3/4 NPT	6 (13.2)
	EFBGM-03Z-20	Rc 1	EFBGM-03Z-2080	1 BSP.F	EFBGM-03Z-2090	1 NPT	
EFBG-06	EFBGM-06X-20	Rc 1	EFBGM-06X-2080	1 BSP.F	EFBGM-06X-2090	1 NPT	12.5 (27.6)
	EFBGM-06Y-20	Rc 1-1/4	EFBGM-06Y-2080	1-1/4 BSP.F	EFBGM-06Y-2090	1-1/4 NPT	16 (35.3)
EFBG-10	EFBGM-10Y-20★	1-1/2, 2 Flange Mounting	EFBGM-10Y-2080★	1-1/2, 2 Flange Mounting	EFBGM-10Y-2090★	1-1/2, 2 Flange Mounting	37 (81.6)

● Sub-plates are available. Specify the sub-plate model number from the table above. When sub-plates are not used, the mounting surface should have a good machined finish.

★ When ordering the EFBGM-10Y, see Type F3 Pipe Flange Kits on the Catalogue No. Pub. EC-3001 and order an appropriate pipe flange kit also.

■ **Instructions**

● **Drain Back Pressure**

Check that the drain back pressure dose not exceed 0.2 MPa (29 PSI).

● **When Relief Valve Passing Flow Rate is Low in Pressure Control State**

To avoid preselected pressure instability, use a passing flow rate of 15 L/min (4.0 U.S.GPM) or higher.

Further, check that the tank-line back pressure dose not exceed 0.5 MPa (70 PSI).

● **Safety Valve Pressure Setting**

The pressure of the safety valve is preset at the value equal to the upper limit of the pressure adjustment range plus 2 MPa (290 PSI). Please adjust the pressure of the valve so preset to meet the pressure to be used actually.

To lower the pressure setting, turn the safety valve pressure adjustment screw anti-clockwise. After adjustment, be sure to tighten the lock nut.

Installation Drawing

Models with Proportional Pilot Relief Valve

EFBG-03-125-^C_H(E)-61/6190

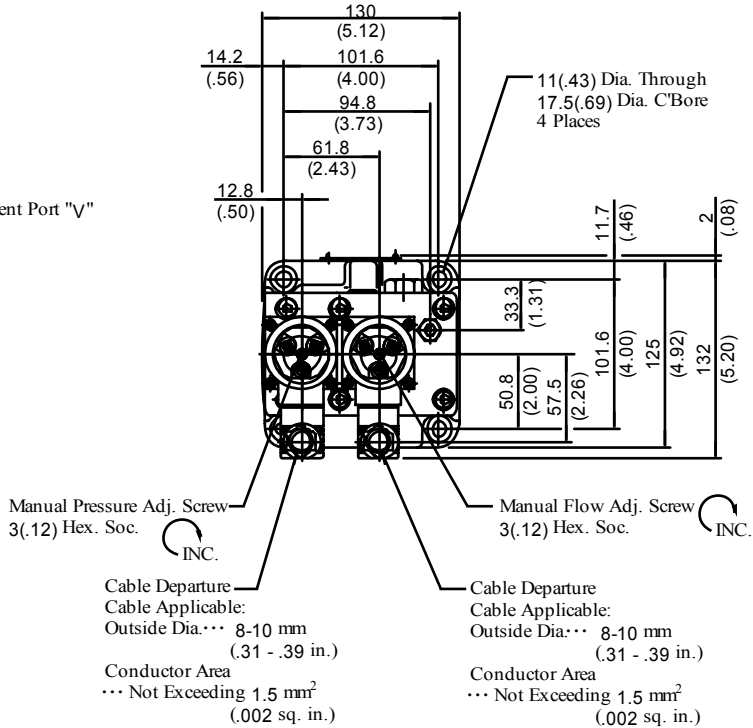
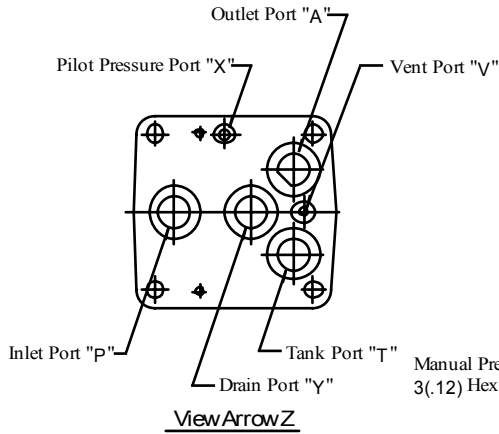

Models without Proportional Pilot Relief Valve

EFBG-03-125-(E)-61/6190

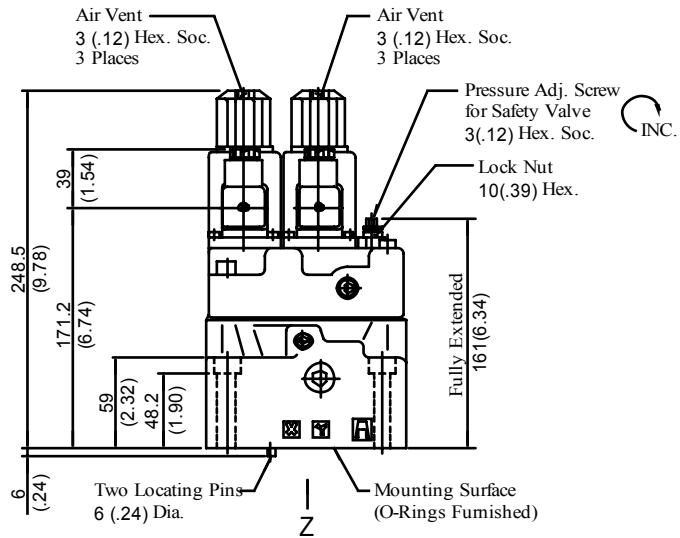
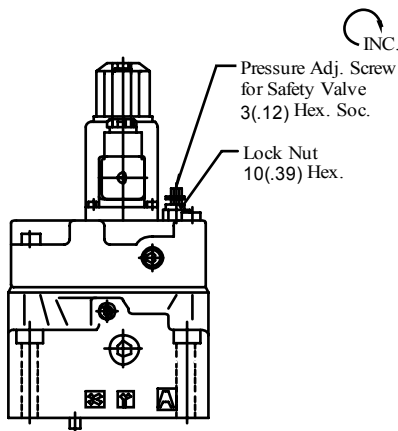
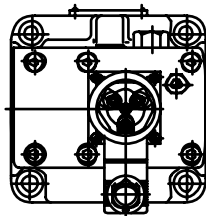

Approx. Mass 14 kg (30.9 lbs.)

**DIMENSIONS IN
MILLIMETRES (INCHES)**

• For other dimensions, please refer to the models with Proportional Pilot Relief Valve.

Approx. Mass 13.3 kg (29.3 lbs.)



Installation Drawing

Models with Proportional Pilot Relief Valve

EFBG-06-250-^C_H(E)-61/6190

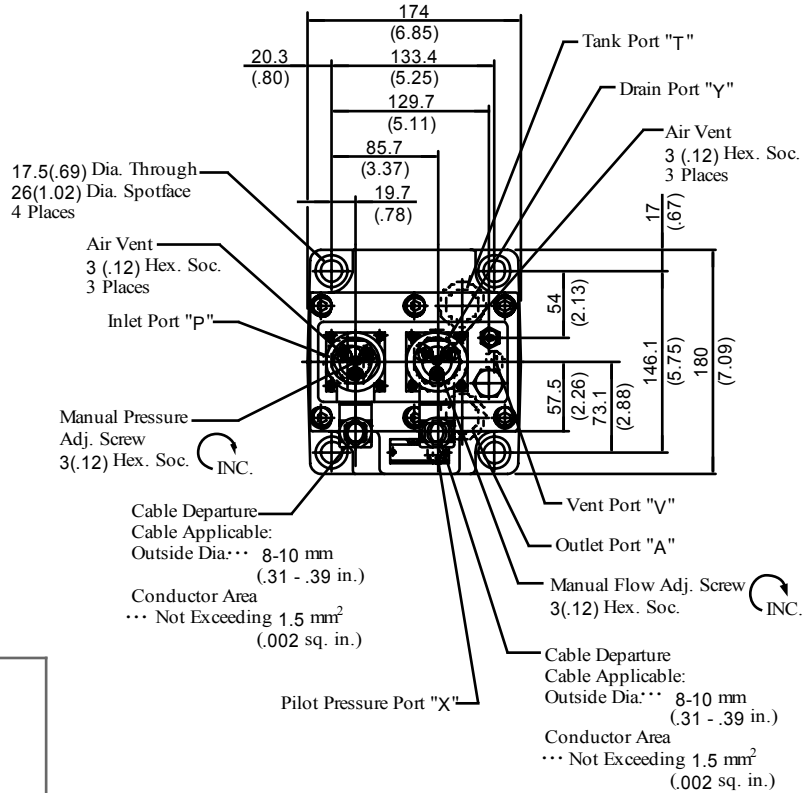

Models without Proportional Pilot Relief Valve

EFBG-06-250-(E)-61/6190

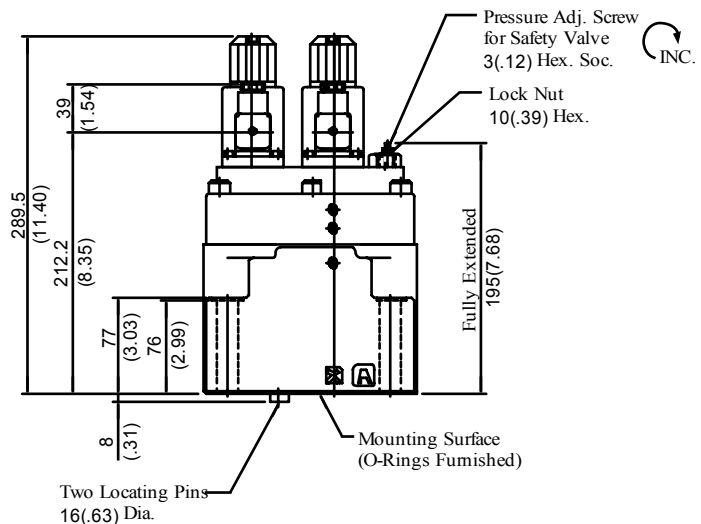
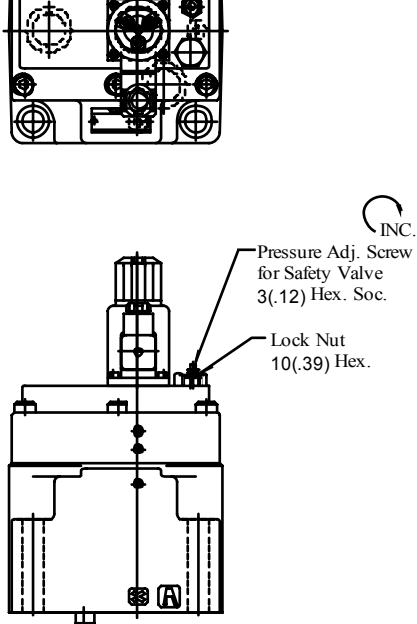
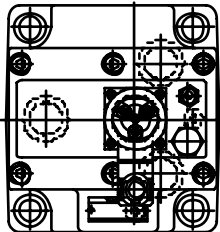

Approx. Mass 22 kg (48.5 lbs.)

• For other dimensions, please refer to the models with Proportional Pilot Relief Valve.

Approx. Mass 21.3 kg (47.0 lbs.)

**DIMENSIONS IN
MILLIMETRES (INCHES)**

Installation Drawing

Models with Proportional Pilot Relief Valve

EFBG-10-500-^C_H(E)-51/5190

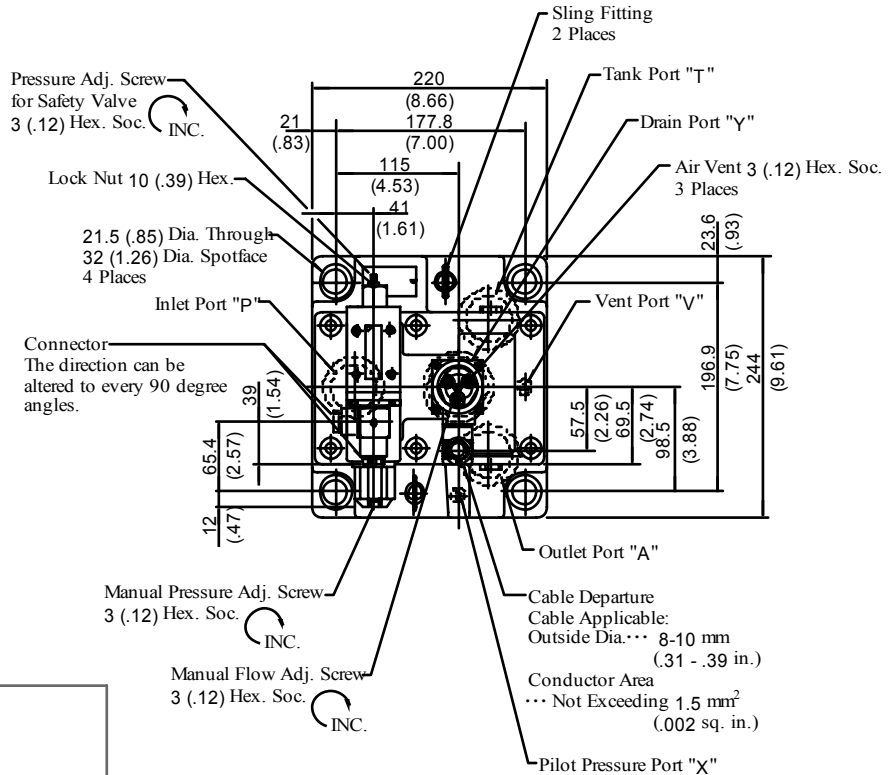

DIMENSIONS IN
MILLIMETRES (INCHES)

Models without
Proportional Pilot Relief Valve

EFBG-10-500-(E)-51/5190

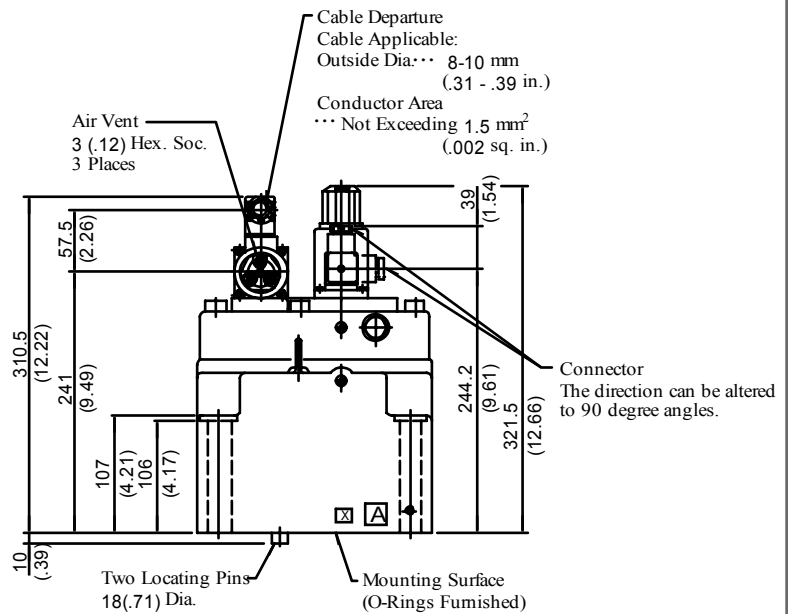
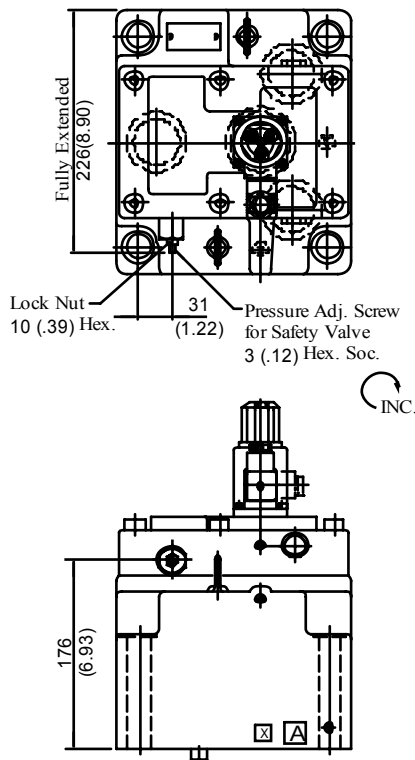

Approx. Mass 64 kg (141 lbs.)

• For other dimensions, please refer to the models with Proportional Pilot Relief Valve.

Approx. Mass 62 kg (137 lbs.)



■ Sub-plate

EFBGM-03Y-20/2080/2090
EFBGM-03Z-20/2080/2090

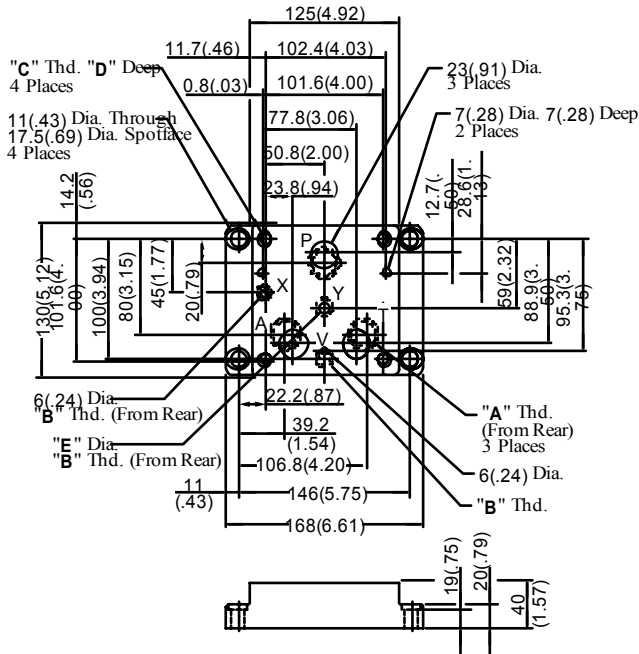

Sub-plate Model Numbers	Thread Size			mm (in.)	
	"A" Thd.	"B" Thd.	"C" Thd.	D	E
EFBGM-03Y-20	Rc 3/4	Rc 1/4	M10	18 (.71)	11 (.43)
EFBGM-03Z-20	Rc 1				11.7 (.46)
EFBGM-03Y-2080	3/4 BSP.F	1/4 BSP.F		21 (.83)	11 (.43)
EFBGM-03Z-2080	1 BSP.F				
EFBGM-03Y-2090	3/4 NPT	1/4 NPT	3/8-16 UNC	11 (.43)	
EFBGM-03Z-2090	1 NPT				

DIMENSIONS IN
MILLIMETRES (INCHES)

EFBGM-06X-20/2080/2090
EFBGM-06Y-20/2080/2090

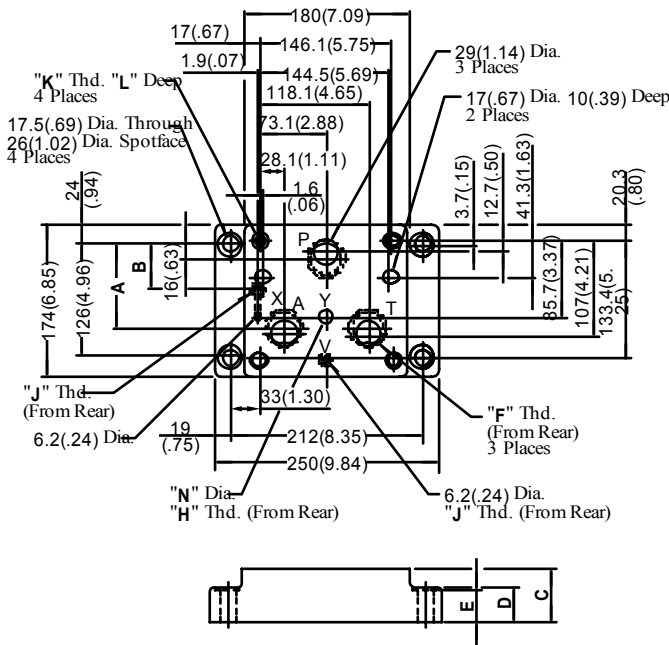

Sub-plate Model Numbers	Dimensions mm (in.)				
	A	B	C	D	E
EFBGM-06X	103.3 (4.07)	63.3 (2.49)	45 (1.77)	35 (1.38)	34 (1.34)
EFBGM-06Y	95 (3.74)	53.3 (2.10)	60 (2.36)	40 (1.57)	39 (1.54)

Sub-plate Model Numbers	Thread Size				mm (in.)	
	"F" Thd.	"H" Thd.	"J" Thd.	"K" Thd.	L	N
EFBGM-06X-20	Rc 1	Rc 3/8	Rc 1/4	M16	30 (1.18)	14 (.55)
EFBGM-06Y-20						
EFBGM-06X-2080	1 BSP.F	3/8 BSP.F	1/4 BSP.F	M16	30 (1.18)	15.2 (.60)
EFBGM-06Y-2080						
EFBGM-06X-2090	1 NPT	3/8 NPT	1/4 NPT	5/8-11 UNC	35 (1.38)	14 (.55)
EFBGM-06Y-2090						

EFBGM-10Y-20/2080/2090

DIMENSIONS IN
MILLIMETRES (INCHES)

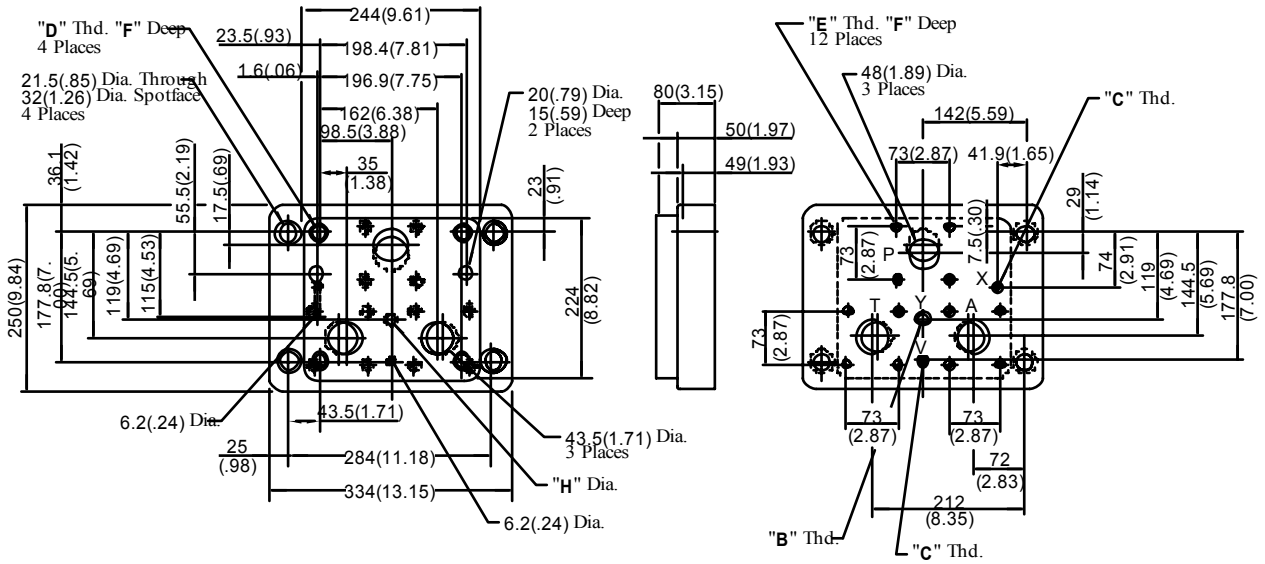

Sub-plate Model Numbers	Thread Size				mm (in.)	
	"B" Thd.	"C" Thd.	"D" Thd.	"E" Thd.	F	H
EFBGM-10Y-20	Rc 3/8	Rc 1/4	M20	M16	32(1.26)	14(.55)
EFBGM-10Y-2080	3/8 BSP.F	1/4 BSP.F				15.2(.60)
EFBGM-10Y-2090	3/8 NPT	1/4 NPT	3/4-10 UNC	5/8-11 UNC	34(1.34)	14(.55)



Typical Performance Characteristics

■ Step Response

These characteristics have been obtained by measuring on each valve. Therefore, they may vary according to a hydraulic circuit to be used.

● Flow Controls

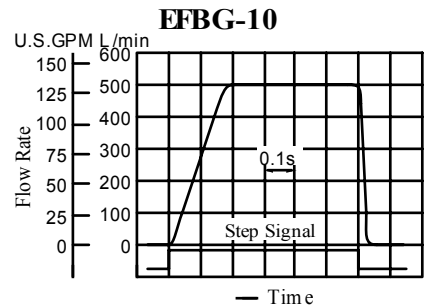
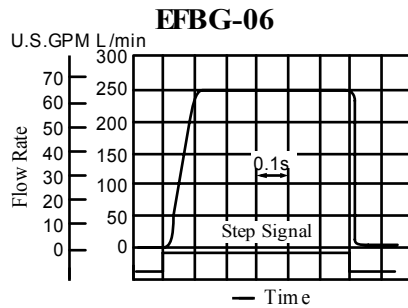
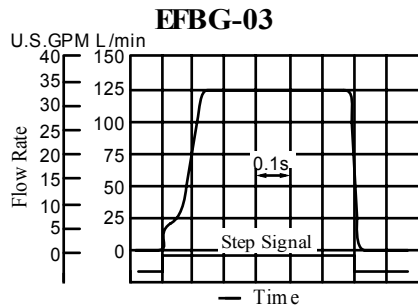

● Pressure Controls

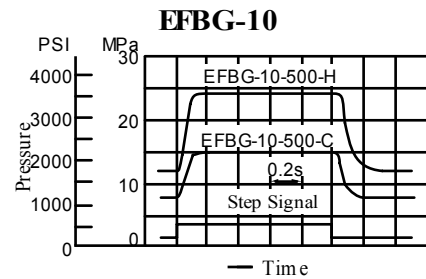
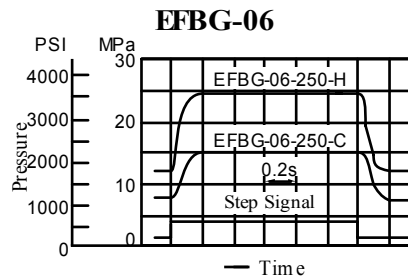
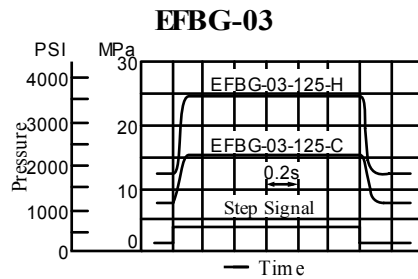

Flow Rate : 125 L/min (33 U.S.GPM)
Trapped Oil Volume: < 1 L (.264 U.S.Gallons)

Flow Rate : 250 L/min (66 U.S.GPM)
Trapped Oil Volume: < 1 L (.264 U.S.Gallons)

Flow Rate : 500 L/min (132 U.S.GPM)
Trapped Oil Volume: < 1 L (.264 U.S.Gallons)

■ Input Current vs. Flow

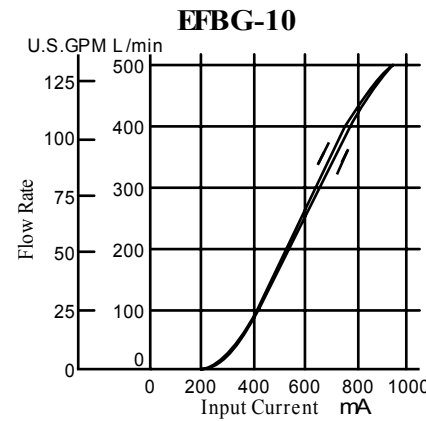
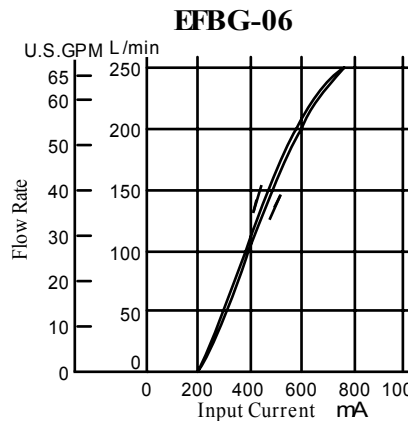
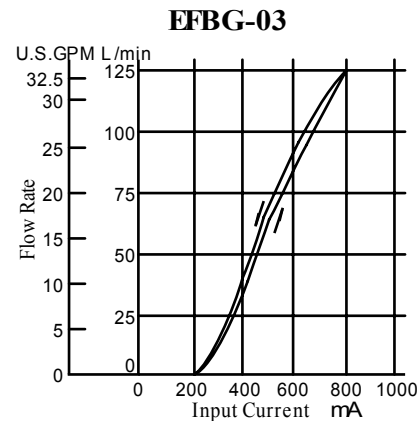

■ Input Current vs. Pressure

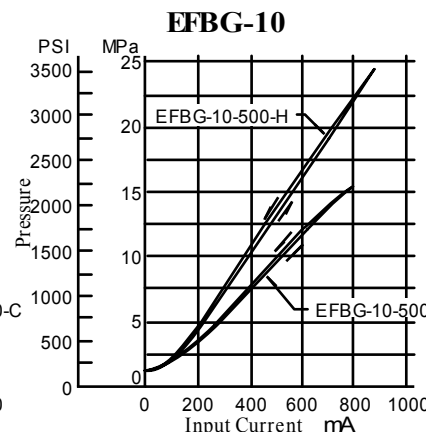
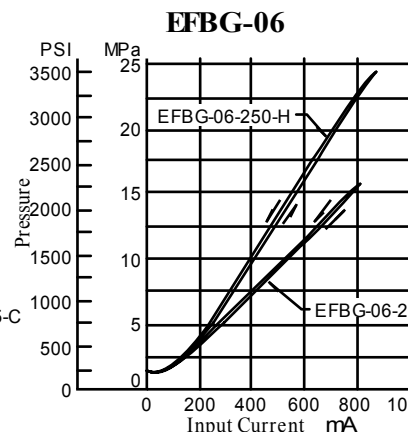
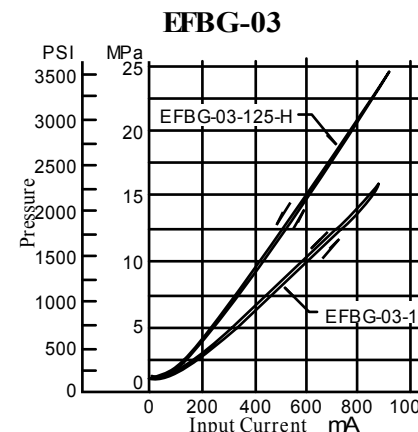

Spare Parts List

EFBG-03-125-*-*-61/6190
EFBG-06-250-*-*-61/6190

CAUTION

When making replacement of seals, please do it carefully after reading through the relevant instructions in the Operator's Manual.

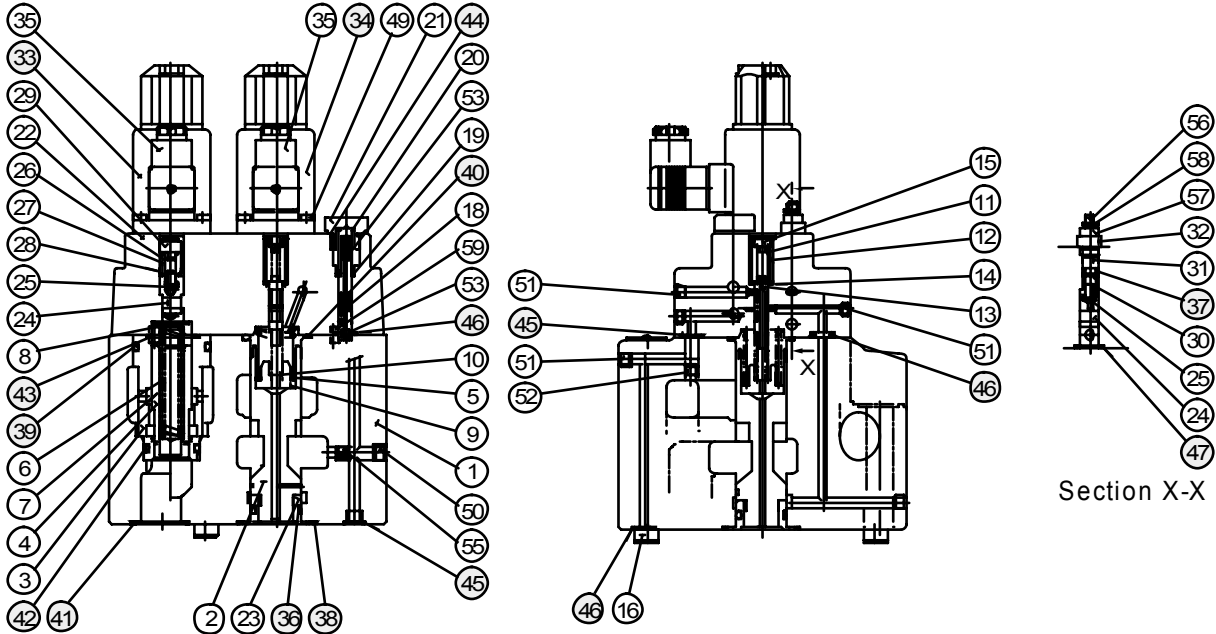

List of Seals

Item	Name of Parts	Part Numbers			
		EFBG-03	Qty.	EFBG-06	Qty.
36	O-Ring	SO-NA-A016	1	SO-NA-P26	1
37	O-Ring	SO-NA-P6	1	SO-NA-P6	1
38	O-Ring	SO-NB-P28	1	SO-NB-P44	1
39	O-Ring	SO-NB-P32	1	SO-NB-P42	1
40	O-Ring	SO-NB-P28	1	SO-NB-P36	1
41	O-Ring	SO-NB-P28	3	SO-NB-P32	3
42	O-Ring	SO-NB-G30	1	SO-NB-P30	1
43	O-Ring	SO-NB-P28	1	SO-NB-P28	1
44	O-Ring	SO-NB-P15	1	SO-NB-P15	1
45	O-Ring	SO-NB-P11	2	SO-NB-P11	2
46	O-Ring	SO-NB-P9	5	SO-NB-P11	4
47	O-Ring	SO-NB-A016	1	SO-NB-A016	1

Note: When ordering seals, please specify the seal kit number from the table right.
In addition to the above o-rings, o-rings for solenoid ass'y are included in the seal kit.
For the detail of the solenoid ass'y seals, see the Catalogue No. Pub. EC-1302.

List of Seal Kits

Model Numbers	Seal Kit Numbers
EFBG-03-125-61*	KS-EFBG-03-61
EFBG-03-125-C/H-61*	KS-EFBG-03-C-61
EFBG-06-250-61*	KS-EFBG-06-61
EFBG-06-250-C/H-61*	KS-EFBG-06-C-61

Solenoid Ass'y

Valve Model Numbers	③③ Solenoid Ass'y Model Numbers	③④ Solenoid Ass'y Model Numbers
EFBG-03-125-C/H-(E)-61/6190	E318-Y06M1-04-61	E318-Y06M1-28-61
EFBG-06-250-C/H-(E)-61/6190		
EFBG-03-125-(E)-61/6190 EFBG-06-250-(E)-61/6190	—	

Note: The connector assembly GDM-211-B-11 (Item 35) is not included in the solenoid assembly.



Spare Parts List

EFBG-10-500-*-51/5190

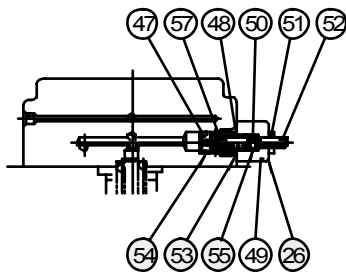
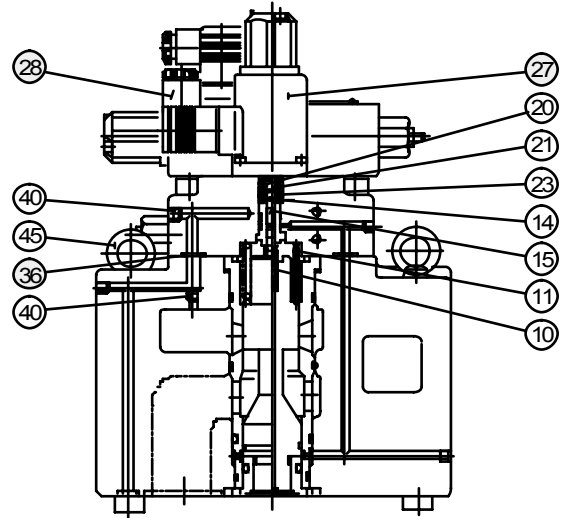
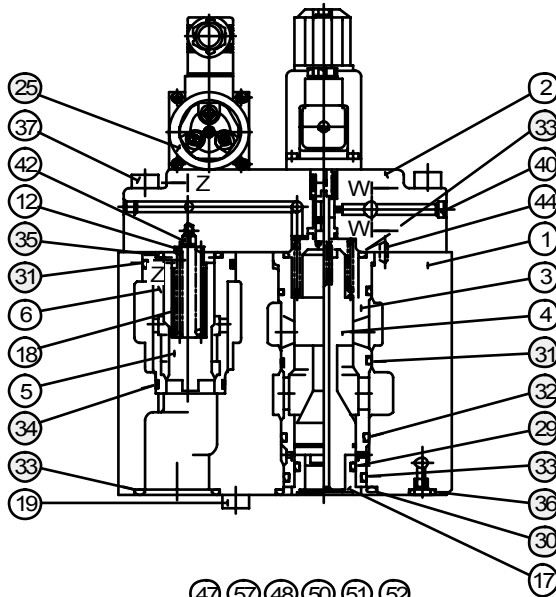

Section W-W
(Only for Models without
Pilot Relief Valve)

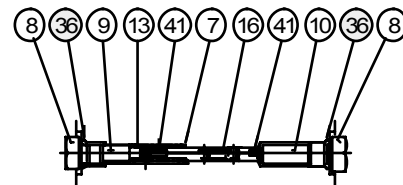

Section Z-Z

● List of Seals

Item	Name of Parts	Part Numbers	Qty.	
			Models with Pilot Relief Valve	Models without Pilot Relief Valve
29	O-Ring	SO-NA-P34	1	1
30	O-Ring	SO-NB-G60	1	1
31	O-Ring	SO-NB-G55	3	3
32	O-Ring	SO-NB-P50	1	1
33	O-Ring	SO-NB-P48	5	5
34	O-Ring	SO-NB-P42	1	1
35	O-Ring	SO-NB-P36	1	1
36	O-Ring	SO-NB-P11	8	8
53	O-Ring	SO-NB-P14	—	1
54	O-Ring	SO-NB-A013	—	1
55	O-Ring	SO-NA-P6	—	1

Note: When ordering seals, please specify the seal kit number from the table right. In addition to the above o-rings, o-rings for pilot valve and solenoid ass'y are included in the seal kit.
For the detail of the pilot valve and solenoid ass'y seals, see the Catalogue No. Pub. EC-1302.

⚠ CAUTION

When making replacement of seals, please do it carefully after reading through the relevant instructions in the Operator's Manual.

● List of Seal Kits

Model Numbers	Seal Kit Numbers
EFBG-10-500-51*	KS-EFBG-10-51
EFBG-10-500-C/H-51*	KS-EFBG-10-C-51

● Pilot Valve and Solenoid Ass'y

Valve Model Numbers	②③ Pilot Valve Model Numbers	②⑦ Solenoid Ass'y Model No.	②⑥ Safety Valve Model No.
EFBG-10-500-C-(E)-51/5190	EDG-01V-C-1-PNT12-5103	E318-Y06M1-28-61	—
EFBG-10-500-H-(E)-51/5190	EDG-01V-H-1-PNT12-5103		—
EFBG-10-500-(E)-51/5190	—		SB1094-2002

Note: The connector assembly GDM-211-B-11 (Item 28) is not included in the solenoid assembly.

Interchangeability between Current and New

■ Interchangeability between Current and New Design

Model changes have been made from 50, 51 to 61 design in the EFBG-03/06 because of changes in the pilot valve building-in method and model changes have been made from 50 to 51-design in the EFBG-10 because of improvement in Solenoid Ass'y.

● Specification and Characteristics

No changes in specifications and characteristics between current and new design

● Interchangeability in Installation

● EFBG-03/06

50* • 51* Design → 61* Design

The mounting surface are interchangeable. However, the method of building in the pilot valve has been changed, bringing about changes in the appearance shapes and dimensions as shown below.

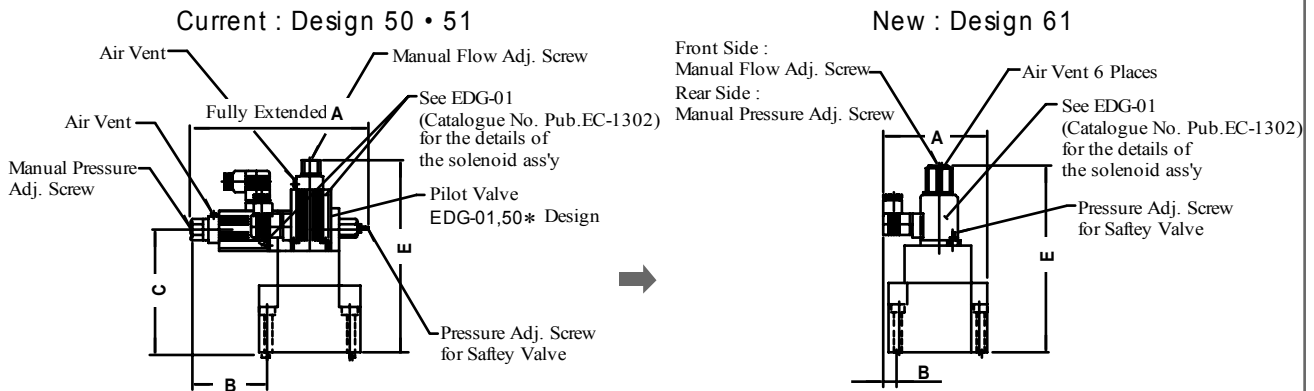

Model Numbers	A	B	C	D
(Current) EFBG-03-125-*-* 50/5090 51/5190	217 (8.54)	93.2 (3.67)	155 (6.10)	236.5 (9.31)
(New) EFBG-03-125-*-* 61/6190	132 (5.20)	18.7 (1.74)	—	248.5 (9.78)
(Current) EFBG-06-250-*-* 50/5090 51/5190	217 (8.54)	53.3 (2.10)	196 (7.72)	277.5 (10.93)
(New) EFBG-06-250-*-* 61/6190	159.5 (6.28)	—	—	289.5 (11.40)

60* Design → 61* Design

The mounting surface are interchangeable. There are no changes in the appearance shapes and dimensions.

● EFBG-10

Mounting compatibility is provided.

Note that because of improvements made on the solenoids, the overall shapes have been changed as shown below.

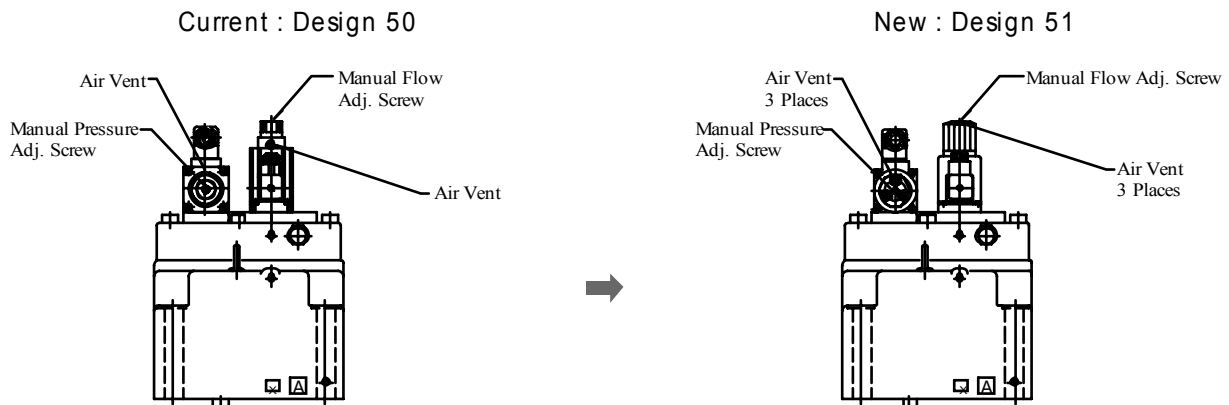

DIMENSIONS IN
MILLIMETRES (INCHES)

Specifications

Specifications

Model No.		EFBG-03 -250-*-*-51*	EFBG-06 -500-*-*-51*
Description			
Max. Operating Pressure MPa (PSI)		24.5 (3550)	24.5 (3550)
Max. Flow L/m in (U.S.GPM)		250 (66)	500 (132)
Metred Flow Adjustment Range L/m in (U.S.GPM)		2.5-250 (.66-66)	5-500 (1.32-132)
Min. Pilot Pressure MPa (PSI)		1.5 (220)	1.5 (220)
Pilot Flow L/m in (U.S.GPM)	at Normal	1 (.26)	1 (.26)
	at Transition	4 (1.06)	6 (1.59)
Flow Controls	Rated Currnt	850 mA	765 mA
	Coil Resistance	10 Ω	10 Ω
	Differential Pressure MPa (PSI)	0.8 (115)	0.9 (130)
	Hysteresis	Less than 3%	Less than 3%
	Repeatability	Less than 1%	Less than 1%
*1 Pressure Controls	Pres. Adj. Range MPa (PSI)	C : 1.6-15.7 (230-2275) H : 1.8-24.5 (260-3550)	C : 1.5-15.7 (220-2275) H : 1.5-24.5 (220-3550)
	Rated Current	C : 850 mA H : 870 mA	C : 820 mA H : 880 mA
	Coil Resistance	10 Ω	10 Ω
	Hysteresis	Less than 3%	Less than 3%
	Repeatability	Less than 1%	Less than 1%
	Approx. Mass kg (lbs.)	Refer to page 46 to 47	

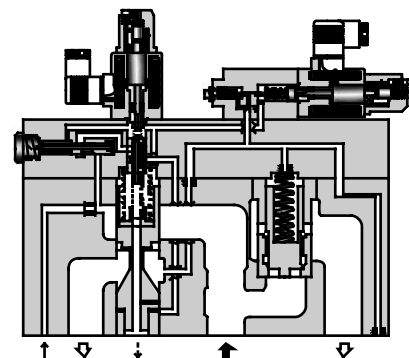

- ★ 1. The specifications for pressure controls are applied to models with proportional pilot relief valve. (Ex. EFBG-03-250-C-*-51)
- ★ 2. The maximum pressure adjustment range of the valves without proportional pilot relief valves is 24.5 MPa (3550 PSI).

Graphic Symbols

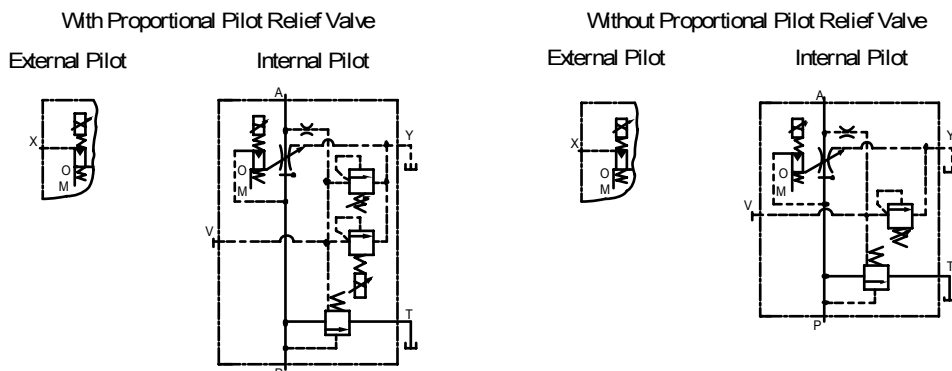

■ **Model Number Designation**

EFB	G	-03	-250	-C	-E	-51	*
Series Number	Type of Mounting	Valve Size	Max. Metred Flow L/min (U.S.GPM)	Proportional Pilot Relief Valve Pressure Adj. Range	Pilot Connection	Design Number	Design Standards
EFB: Proportional Electro-Hydraulic Flow Control and Relief Valve	G: Sub-plate Mounting	03	250: 250 (66)	C, H: See Specifications None: Without Proportional Pilot Relief Valve	None: Internal Pilot E: External Pilot	51	Refer to ★
		06	500: 500 (132)			51	

★ Design Standards: None Japanese Standard "JIS" and European Design Standard
 90 N. American Design Standard

■ **Attachment**

● **Mounting Bolts**

Valve Model Numbers	Socket Head Cap Screw		Qty.
	Japanese Std. "JIS" and European Design Std.	N. American Design Std.	
EFBG-03	M12 × 120 Lg.	1/2-13 UNC × 4-3/4 Lg.	4
EFBG-06	M16 × 120 Lg.	5/8-11 UNC × 4-3/4 Lg.	4

■ **Applicable Power Amplifiers**

For stable performance, it is recommended that Yuken's applicable power amplifiers be used (for details see the Catalogue No. Pub. EC-1305).

Model Numbers	Power Amplifier Model Numbers	
	For Flow Control	For Pres. Control
EFBG-03-250(-E)-51/5190 EFBG-06-500(-E)-51/5190	AME-D-10-*-20 AMN-D-10 (For DC power supply)	—
EFBG-03-250-C/H(-E)-51/5190 EFBG-06-500-C/H(-E)-51/5190	AME-D2-1010-*-10	

■ **Instructions**

● **Drain Back Pressure**

Check that the drain back pressure dose not exceed 0.2 MPa (29 PSI).

● **When Relief Valve Passing Flow Rate is Low in Pressure Control State**

To avoid preselected pressure instability, use a passing flow rate of 15 L/min (4.0 U.S.GPM) or higher. Further, check that the tank-line back pressure dose not exceed 0.5 MPa (70 PSI).

● **Safety Valve Pressure Setting**

The pressure of the safety valve is preset at the value equal to the upper limit of the pressure adjustment range plus 2 MPa (290 PSI). Please adjust the pressure of the valve so preset to meet the pressure to be used actually. To lower the pressure setting, turn the safety valve pressure adjustment screw anti-clockwise. After adjustment, be sure to tighten the lock nut.

● **Interchangeability in installation with conventional valves (10Ω -10Ω Series)**

• EFBG-03

There is no interchangeability in installation.

• EFBG-06

A product in the high-flow series can be mounted on the conventional mounting surface but no conventional product can be mounted on the mounting surface of the high-flow series.



Installation Drawing

EFBG-03-250-C(-E)-51/5190, EFBG-03-250 (-E)-51/5190

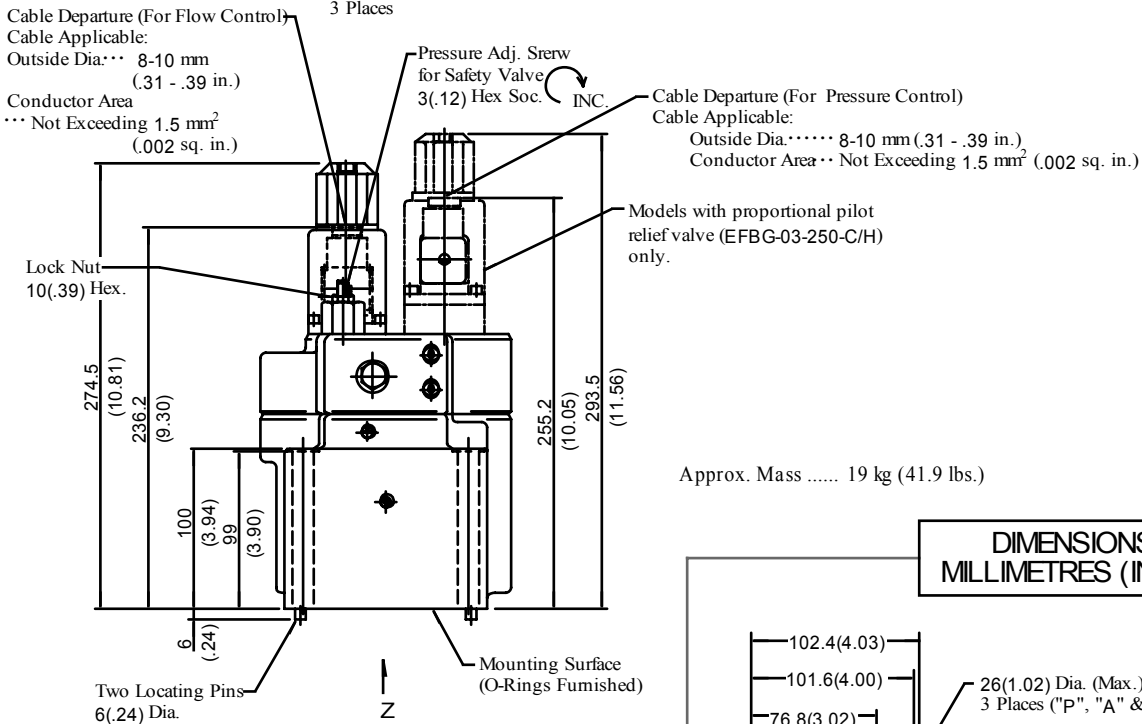
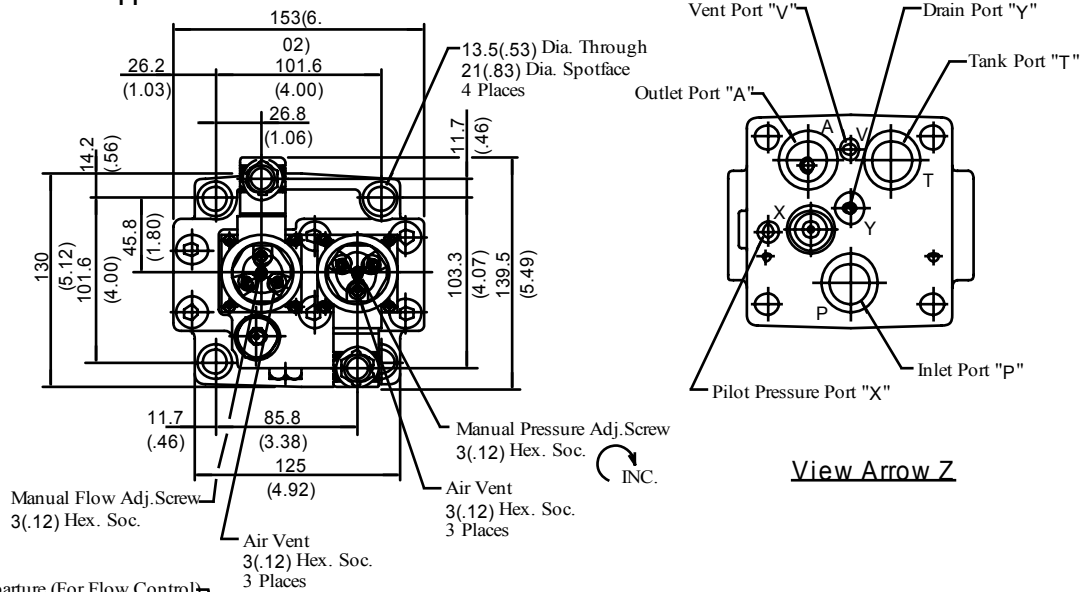

Dimensions of valve mounting surface

Prepare a mounting surface as shown to the right. Also finish it finely.

Model Numbers	"B" Thd.
EFBG-03-250-*-51	M12
EFBG-03-250-*-5190	1/2-13 UNC

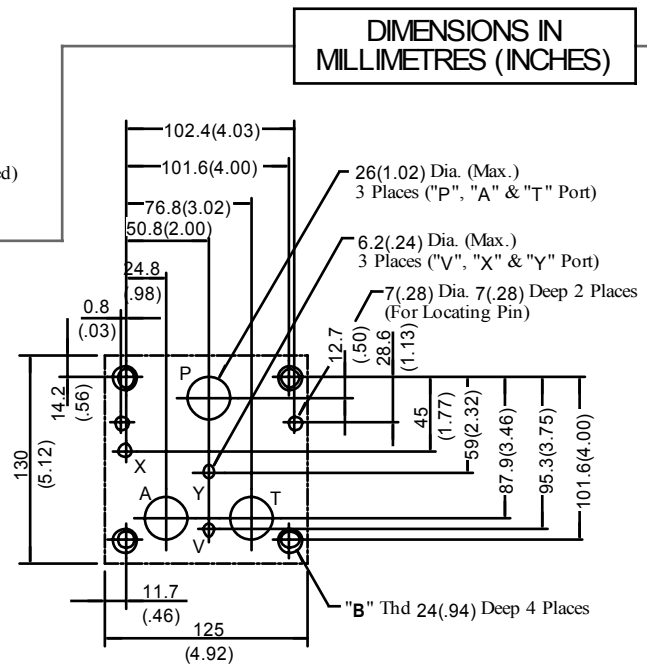

Installation Drawing

Models with Proportional Pilot Relief Valve EFBG-06-500-C_H(-E)-51/5190

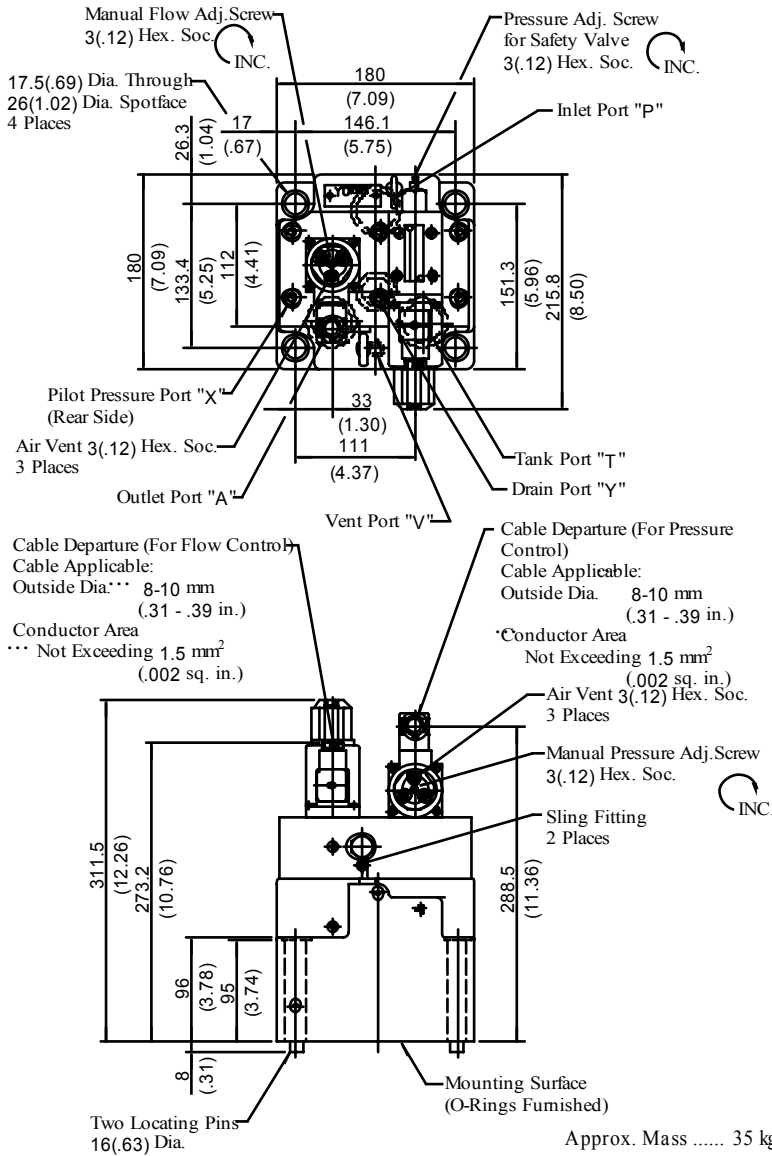

Models without Proportional Pilot Relief Valve EFBG-06-500(-E)-51/5190

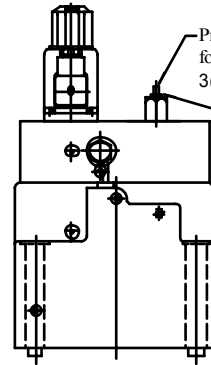
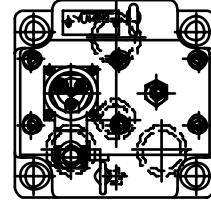

Pressure Adj. Screw for Safety Valve 3(12) Hex. Soc. INC.

Lock Nut 10(.39) Hex.

• For other dimensions, please refer to the models with Proportional Pilot Relief Valve.

Approx. Mass 33 kg (72.8 lbs.)

DIMENSIONS IN MILLIMETRES (INCHES)

Dimensions of valve mounting surface

Prepare a mounting surface as shown to the right. Also finish it finely.

Model Numbers	"B" Thd.	C
EFBG-06-500-*-51	M16	30 (1.18)
EFBG-06-500-*-5190	5/8-11 UNC	35 (1.38)

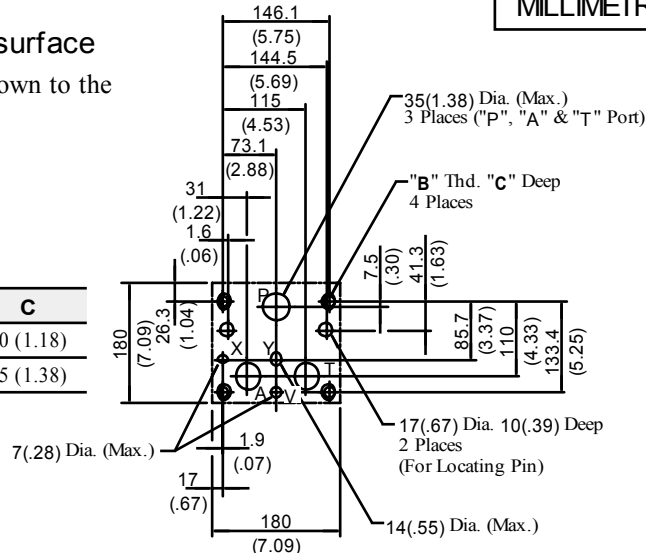

Typical Performance Characteristics

■ Step Response

These characteristics have been obtained by measuring on each valve. Therefore, they may vary according to a hydraulic circuit to be used.

● Flow Controls

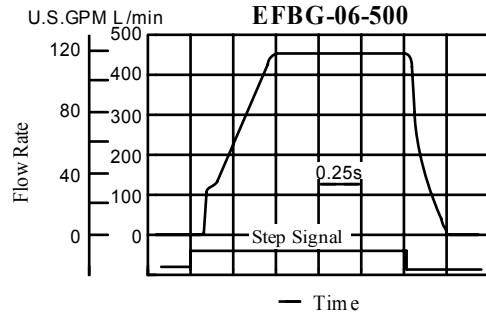
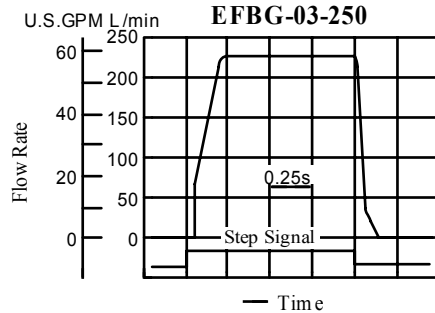

● Pressure Controls

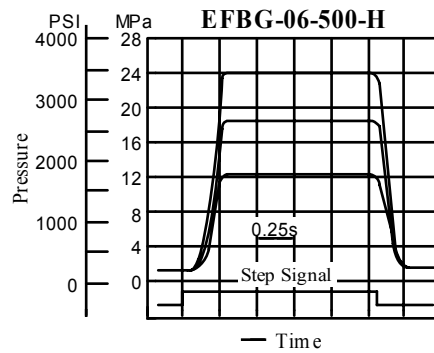
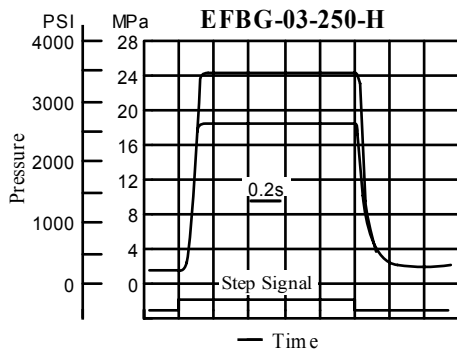

■ Input Current vs. Flow

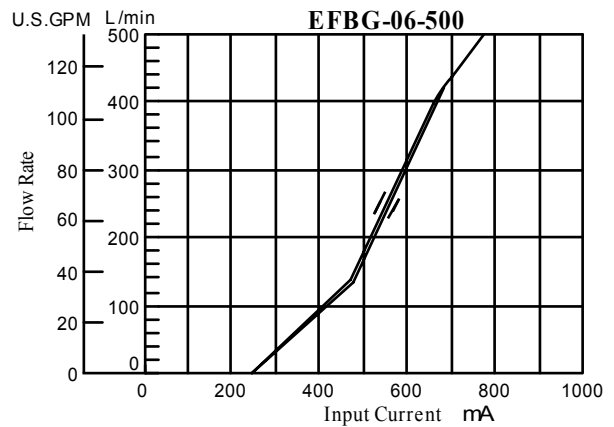
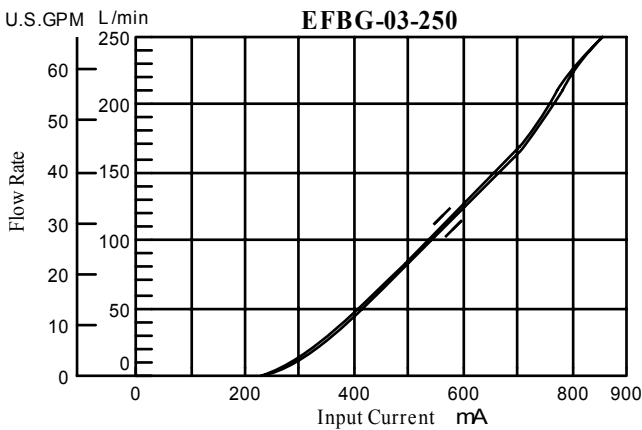

■ Input Current vs. Pressure

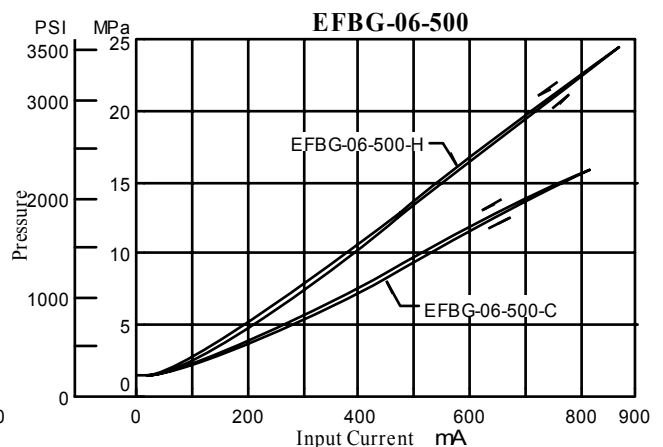
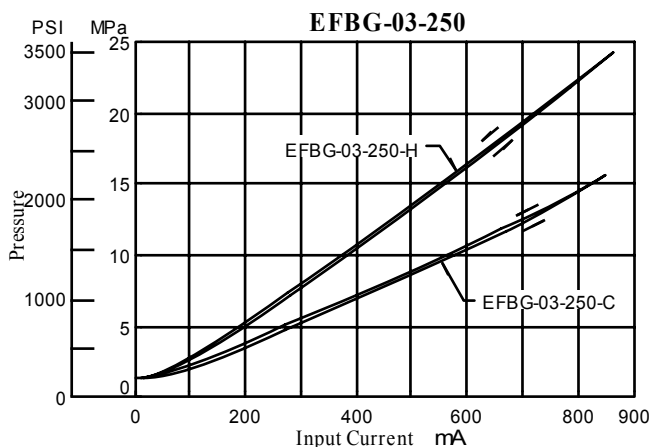

Spare Parts List

EFBG-03-250-*-*-51/5190

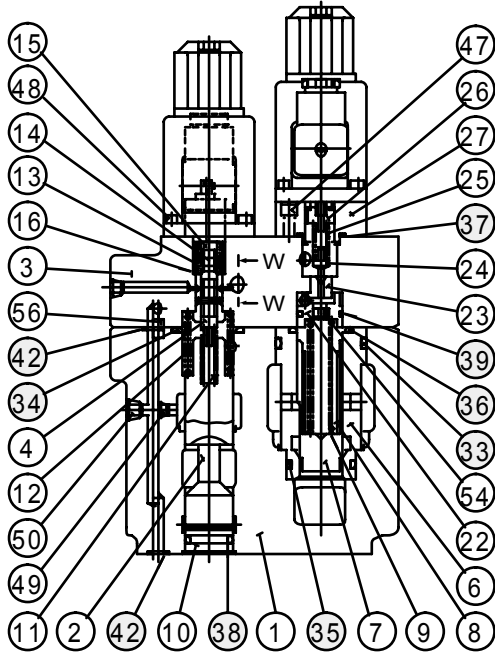
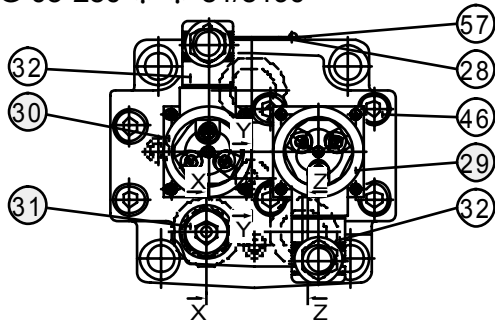

Detail of Safety Valve
(Item 31)

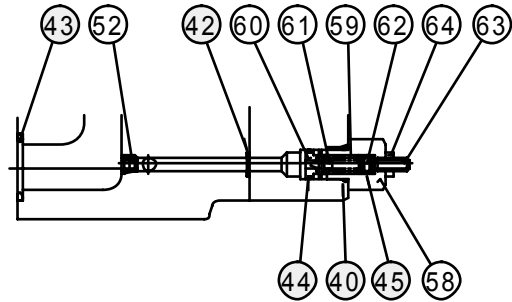

Section X-X

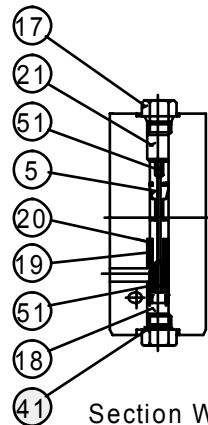

Section W-W

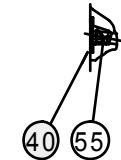

Section Y-Y



Section Z-Z

● List of Seals

Item	Name of Parts	Part Numbers	Qty.
33	O-Ring	SO-NB-P42	1
34	O-Ring	SO-NB-P32	1
35	O-Ring	SO-NB-P30	1
36	O-Ring	SO-NB-P28	1
37	O-Ring	SO-NB-P22	1*
38	O-Ring	SO-NB-P21	1
39	O-Ring	SO-NB-P20	1*
40	O-Ring	SO-NB-P14	2
41	O-Ring	SO-NB-P11	2
42	O-Ring	SO-NB-P9	6
43	O-Ring	SO-NB-G30	3
44	O-Ring	SO-NB-A013	1
45	O-Ring	SO-NA-P6	1

★O-rings, ref. Nos. 37 and 39, are used only with the proportional pilot relief valve (EFBG-03-250-C/H).

Note: When ordering seals, please specify the seal kit number from the table right.

In addition to the above o-rings, o-rings for solenoid ass'y are included in the seal kit.

For the detail of the solenoid ass'y seals, see the Catalogue No. Pub. EC-1302.

● Solenoid Ass'y and Safety Valve

Valve Model Numbers	29 Solenoid Ass'y Model No.	60 Solenoid Ass'y Model No.	61 Safety Valve Model No.
EFBG-03-250-C/H(-E)-51/5190	E318-Y06M1-04-61	E318-Y06M1-28-61	SB1094-2002
EFBG-03-250(-E)-51/5190	—		

Note: The connector assembly GDM-211-B-11 (Item 32) is not included in the solenoid assembly.

⚠ CAUTION

When making replacement of seals, please do it carefully after reading through the relevant instructions in the Operator's Manual.

● List of Seal Kits

Model Numbers	Seal Kit Numbers
EFBG-03-250-51*	KS-EFBG-03-250-51
EFBG-03-250-C/H-51*	KS-EFBG-03-250-C-51

Spare Parts List

EFBG-06-500-*-51/5190

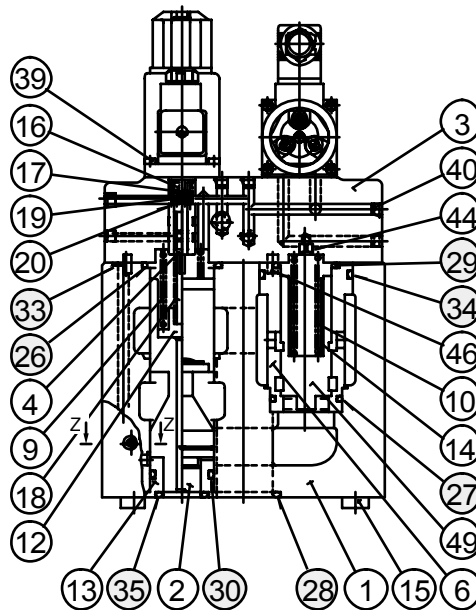
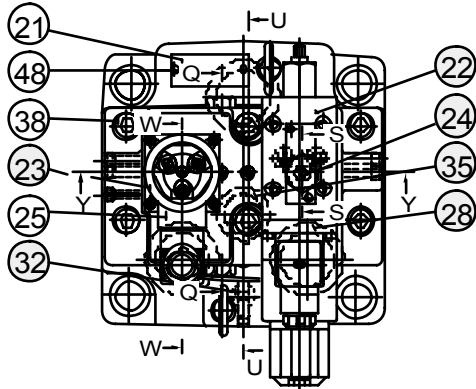

● List of Seals

Item	Name of Parts	Part Numbers	Qty.
26	O-Ring	SO-NB-P46	1
27	O-Ring	SO-NB-P42	1
28	O-Ring	SO-NB-P40	3
29	O-Ring	SO-NB-P36	1
30	O-Ring	SO-NB-P34	1
31	O-Ring	SO-NB-P14	1 [★]
32	O-Ring	SO-NB-P11	4
33	O-Ring	SO-NB-P9	4
34	O-Ring	SO-NB-G55	1
35	O-Ring	SO-NB-G30	2
36	O-Ring	SO-NB-AO13	1 [★]
37	O-Ring	SO-NA-P6	1 [★]

★ O-rings, ref. Nos. 31, 36 and 37, are used only with the proportional pilot relief valve [EFBG-06-500(-E)].

Note: When ordering seals, please specify the seal kit number from the table right. In addition to the above o-rings, o-rings for pilot valve and solenoid ass'y are included in the seal kit. For the detail of the pilot valve and solenoid ass'y seals, see the Catalogue No. Pub. EC-1302.

● Pilot Valve and Solenoid Ass'y

Valve Model Numbers	② Pilot Valve Model Numbers	③ Solenoid Ass'y Model No.	④ Safety Valve Model No.
EFBG-06-500-C(-E)-51/5190	EDG-01V-C-1-PNT11-5103	E318-Y06M1-28-61	—
EFBG-06-500-H(-E)-51/5190	EDG-01V-H-1-PNT11-5103		—
EFBG-06-500(-E)-51/5190	—		SB1094-2002

Note: The connector assembly GDM-211-B-11 (Item 25) is not included in the solenoid assembly.

Detail of Safety Valve
Model (with 24) Pilot
Relief
Valve : EFBG-06-500(-E)

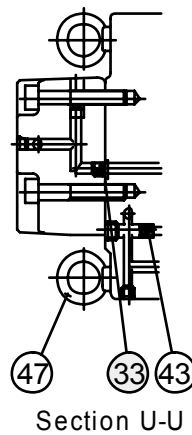
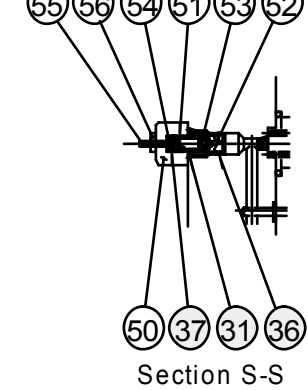

Section U-U

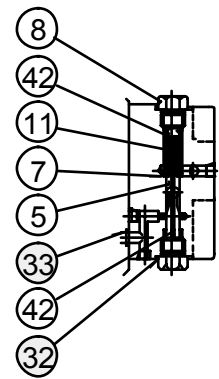

Section Q-Q

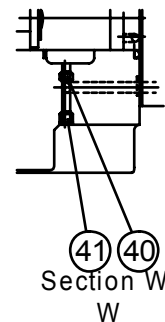

Section W-W

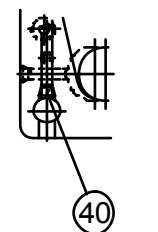

Section Z-Z

⚠ CAUTION

When making replacement of seals, please do it carefully after reading through the relevant instructions in the Operator's Manual.

● List of Seal Kits

Model Numbers	Seal Kit Numbers
EFBG-06-500-51*	KS-EFBG-06-500-51
EFBG-06-500-C/H-51*	KS-EFBG-06-500-C-51

Interchangeability between Current and New

■ Interchangeability between Current and New Design

EFBG-03/06 series valves have changed model from 50 to 51 design in line with the model change of solenoid ass'y.

● Specifications and Characteristics

No changes in specifications and characteristics between current and new design.

● Mounting Interchangeability

There is an interchangeability in the mounting dimensions between current and new design, however, note that because of improvements made on the solenoids, the overall shapes have been changed as shown below.

● EFBG-03

Current : Design 50

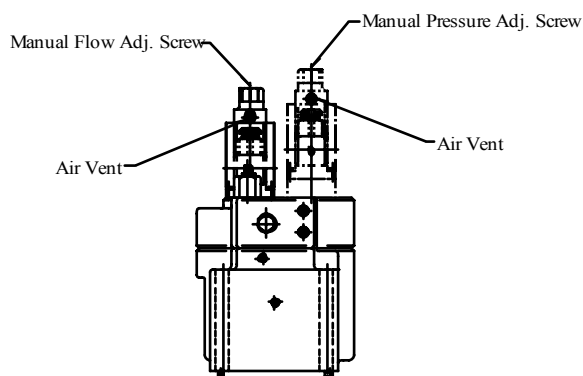

New : Design 51

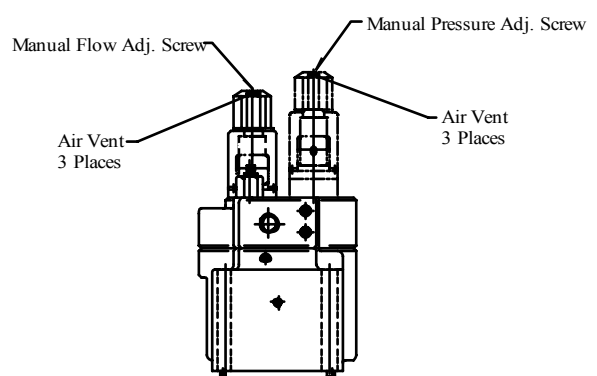

● EFBG-06

Current : Design 50

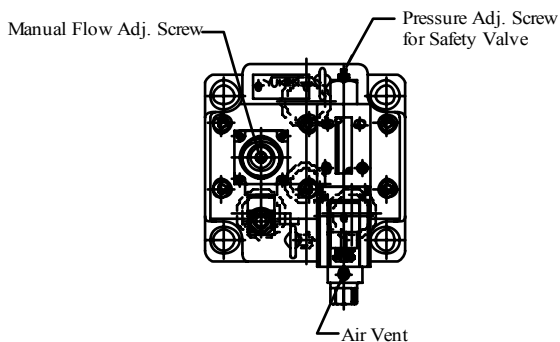

New : Design 51

